

SOPHSTONE

Edition
Six

Where
function + art
coexist

PASSION
not trends



Residential
Spring
2024





DNA + CORE VALUE

Origin (Sophisticated + Stone)	6-7
Location (Mind, Body, and Spirit)	8-9
Passion (Beautiful Objects)	10-11
Craftsmanship (Human Touch)	12-13
Material (Feel the Difference)	14-15
Exclusivity (Limited Production)	16-17
A SOPHSTONE Design	18-19

PRODUCTS

FreeStanding Bathtub	22-44
Ofuro Japanese Soaking Tub	46-49
FreeStanding Basin	50-69
Vessel Sink	70-90
Integrated Counter Sinks	92-117

SOLUTIONS & INFORMATION

Colour Dua	122 -123
Pantone Color Matching	124-125
Bespoke Department	126-129
Color Chart	130-131

SOPHSTONE

“Be as passionate about the product you manufacture
as the relationships you forge” — *Gil Saul*





ORIGIN

SOPHISTICATED STONE

Born in 2017 under the creative direction of artist Gil Saul and longtime friend Brandon Caldwell, **SOPHSTONE** speaks to a niche clientele which values individuality over current trends. The symbolism of the minimalistic logo, two vertical lines on each side of the (S) represent the bond between two friends and a brand done differently.

Driven more by creativity than profits, **SOPHSTONE** remains steadfastly independent. A family-owned boutique manufacturer, providing the flexibility required to incorporate age-old techniques and old-world craftsmanship absent in a market saturated by global brands.



LOCATION

RELAXING MIND, BODY AND SPIRIT

Within the picturesque surroundings of Bali, Indonesia, Gil borrows inspiration, not from concrete and steel, but rather the harmony of living within nature. There is a realization that tradition, craftsmanship, and innovation can coexist. Overcoming the familiar and continually producing recognizable, ambitious, and culturally relevant luxury. The **SOPHSTONE** brand is proudly manufactured entirely in-house, creating exclusive, original designs of uncompromising quality.





PASSION

BEAUTIFUL OBJECTS

From the seeds of creation right through to the production of every **SOPHSTONE** product, our passion for design, creativity, and beautiful objects is what guides us. A flair for thinking outside the box. Focusing on indulgence and relaxation, form and function must live in harmony. We succeed only by being passionate.

"If you analyze the function of an object, its form often becomes obvious."

-
Professor Ferdinand Alexander Porsche.

CRAFTSMANSHIP

HUMAN TOUCH

No product created by the human hand will ever be without flaws, yet the human touch is vital to **SOPHSTONE's** philosophy of unrivaled craftsmanship. There is beauty within the subtle flaws of imperfection and warmth in the human touch. At the same time, SOPHSTONE has standards and practices throughout its manufacturing process that are as rigorous as any you'll find in any industry. The perfect balance between modernity and tradition.

SOPHSTONE is individually and meticulously handcrafted by exceptional people, applying stunning attention to detail and taking enormous pride in the brand they help create.





FEEL THE
DIFFERENCE

MATERIAL

VELVET SOFT

A **SOPHSTONE** product can be recognized simply by running your fingers across the surface. Embracing your sense of touch. Great pride was taken by starting from scratch, engineering a material that satisfied all our core values. From reclaimed and re-purposed fine glass powder, to the highest quality resins and all natural raw minerals, our standard and practice is to always place quality over cost.

The end result is what defines us, **SOPHSTONE**, the Brand and the Material. Environmentally conscious, durable, versatile, and unlike other global products, absolutely pleasant to the touch.

SOPHSTONE, feel the difference.



EXCLUSIVITY

LIMITED PRODUCTION

SOPHSTONE is an independent entity, financially and creatively, and does not live in the world of global branding and mass production. This gives us total independence in our values and our artistic perspectives. Manufacturing is done by hand for the simple reason that it is impossible to meet our standard using machines alone. This ensures limited production and exclusivity for those who purchase.



EXCLUSIVE
ORIGINAL DESIGNS



WHERE
FUNCTION
+ **ART** COEXIST

A **SOPHSTONE** DESIGN

SOPHSTONE is individually and meticulously handcrafted by exceptional people, applying stunning attention to detail and taking enormous pride in the Brand they help create.

A **SOPHSTONE** design has key attributes making it unique and easily recognizable in the industry.

- Construction
- Design
- Shape

Dual wall construction ensures the inner shape is not restricted by the outside design. Each entity being independent of the other, allows unique outside silhouettes while embracing indulgence and relaxation.

Authentic designs inspired by nature and our surroundings, not industry trends. Individuality is what drives us.

Elegant yet contemporary shapes, many asymmetrical in design. Elevating our thoughts and redesigning the perception of what the bath should look like. Luxurious yet comfortable. Embracing indulgence and relaxation. Encapsulating the mind body and spirit. This is...

The SOPHSTONE Experience.





OUR PRODUCTS

FreeStanding Bathtub	22-44
Ofuro Japanese Bathtub	46-49
FreeStanding Basin	50-69
Vessel Sink	70-90
Integrated Counter Sink	92-117





FREESTANDING BATHTUB

THE COLLECTIONS:

AHRI	26	ELIZABETH	30	MARINA	34	MASON	38	PHOENIX	42
BRANDI	27	ISABEL	31	MARCELA	35	MAREA	39	SERENE	43
CHRISTOPH	28	JULIA	32	MIA	36	NOBLE	40	SILVA	44
DANIELLE	29	MADISON	33	MIKAYLA	37	OLIVIA	41		





AHRI COLLECTION

COLLECTION:	AHRI / SOPH-AIT
Material:	Mineral Glass Composite
Finish:	Satin Honed Finished
Dimension:	1905mm x 915mm x 610mm
Weight:	133 kg (294 lbs)
Depth to Overflow:	433 mm
Water Capacity:	270 L (71 GL)
Available Options:	Colour Dua Pantone Matching

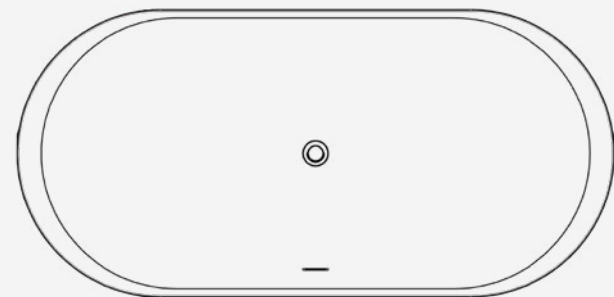

TOP

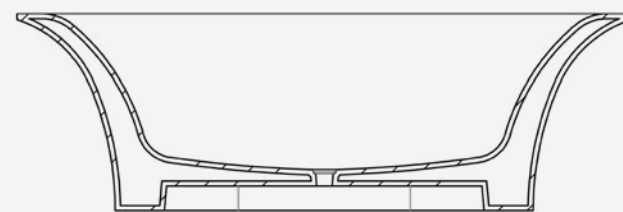

FRONT

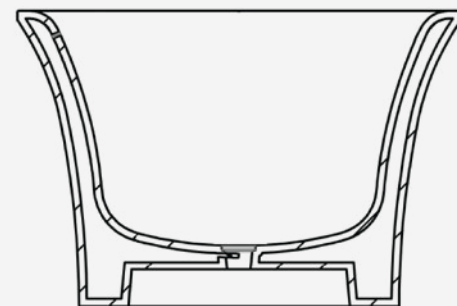

SIDE



BRANDI COLLECTION

COLLECTION:	BRANDI / SOPH-BIT
Material:	Mineral Glass Composite
Finish:	Satin Honed Finished
Dimension:	1550mm x 1550mm x 593mm
Weight:	163 kg (359 lbs)
Depth to Overflow:	403 mm
Water Capacity:	496 L (131 GL)
Available Options:	Colour Dua Pantone Matching

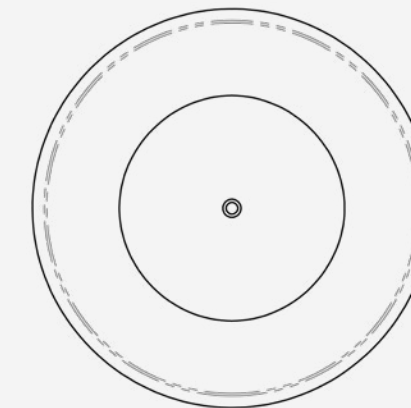

TOP



FRONT



SIDE

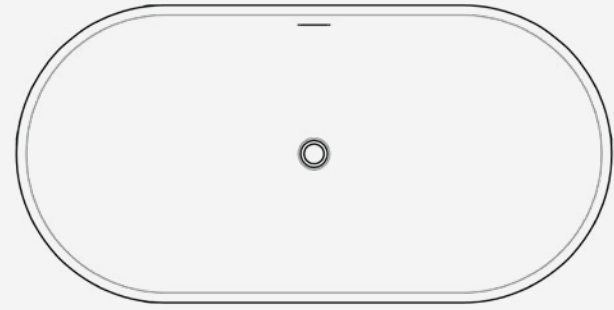

TOP

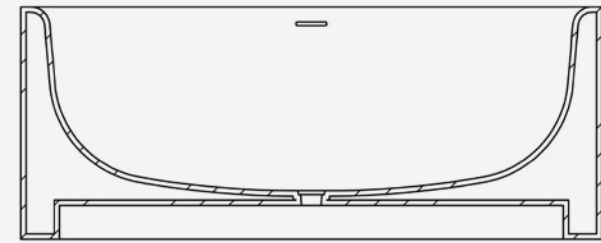

FRONT

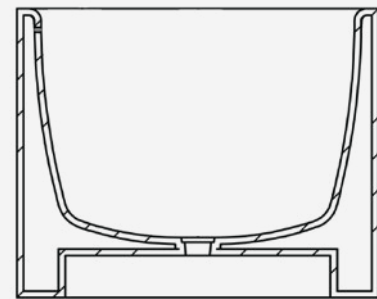

SIDE



CHRISTOPH COLLECTION

COLLECTION:

Material:

Finish:

Dimension:

Weight:

Depth to Overflow:

Water Capacity:

Available Options:

CHRISTOPH / SOPH-CIT

Mineral Glass Composite

Satin Honed Finished

1524mm x 762mm x 610mm

118 kg (260 lbs)

433 mm

287 L (76 GL)

Colour Dua

Pantone Matching

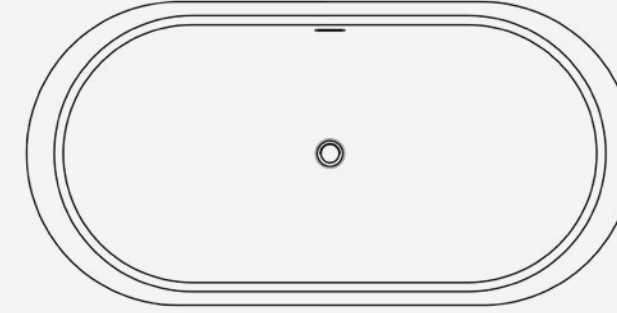

TOP

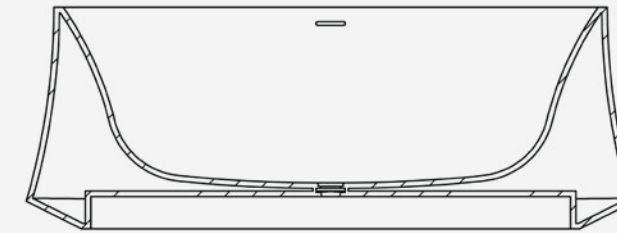

FRONT

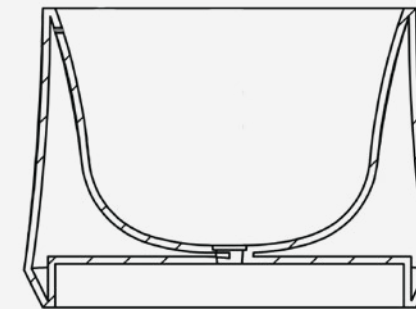

SIDE



DANIELLE COLLECTION

COLLECTION:

Material:

Finish:

Dimension:

Weight:

Depth to Overflow:

Water Capacity:

Available Options:

DANIELLE / SOPH-DIT

Mineral Glass Composite

Satin Honed Finished

1676mm x 838mm x 610mm

129 kg (284 lbs)

433 mm

265 L (70 GL)

Colour Dua

Pantone Matching



ELIZABETH

COLLECTION

COLLECTION: ELIZABETH / SOPH-EIT

Material: Mineral Glass Composite
 Finish: Satin Honed Finished
 Dimension: 1920mm x 1060mm x 600mm
 Weight: 155 kg (341 lbs)
 Depth to Overflow: 430 mm
 Water Capacity: 373 L (98 GL)
 Available Options: Colour Dua
 Pantone Matching

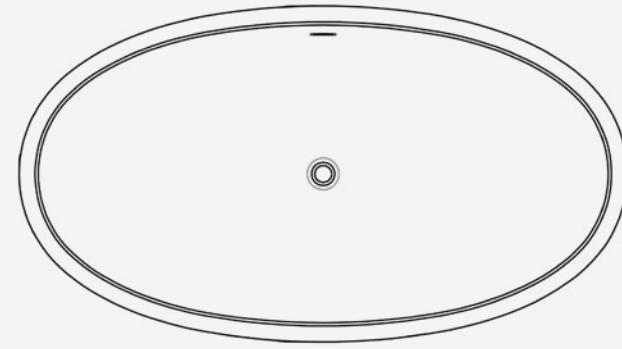

TOP

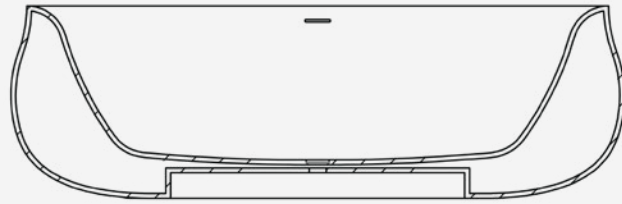

FRONT

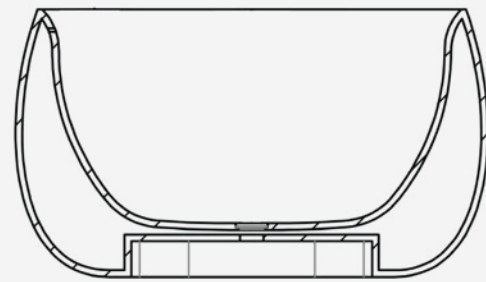

SIDE

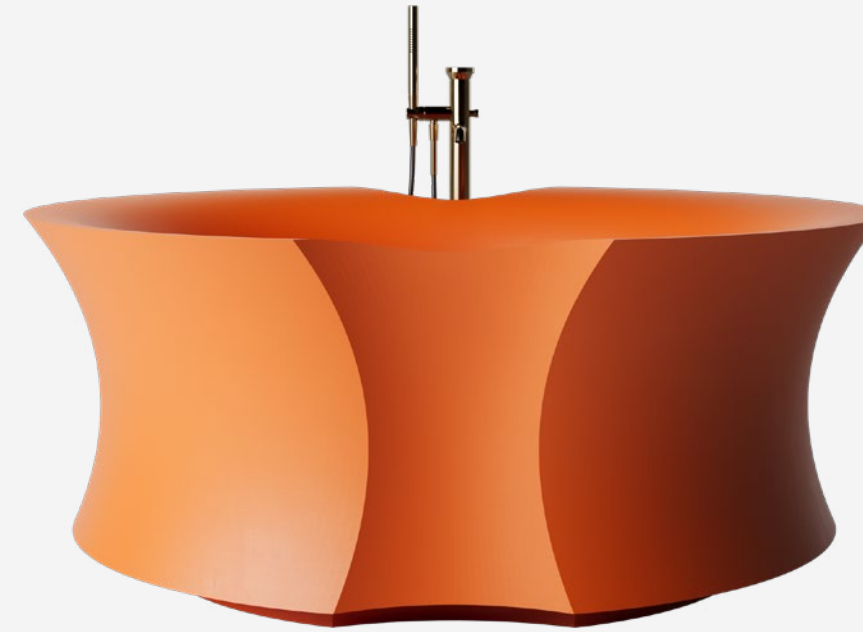

ISABEL

COLLECTION

COLLECTION: ISABEL / SOPH-IIT

Material: Mineral Glass Composite
 Finish: Satin Honed Finished
 Dimension: 1524mm x 1524mm x 635mm
 Weight: 167 kg (368 lbs)
 Depth to Overflow: 409 mm
 Water Capacity: 322 L (85 GL)
 Available Options: Colour Dua
 Pantone Matching

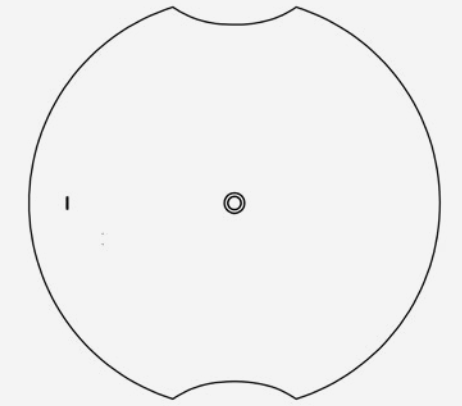

TOP

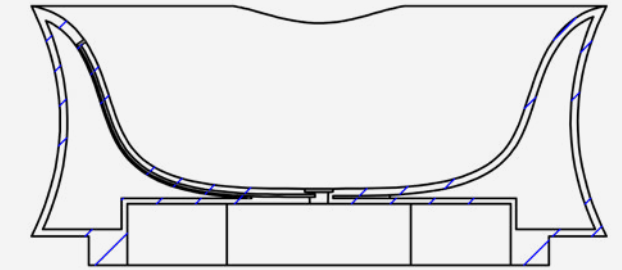

FRONT

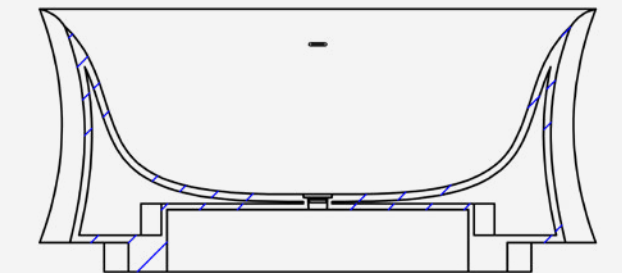

SIDE

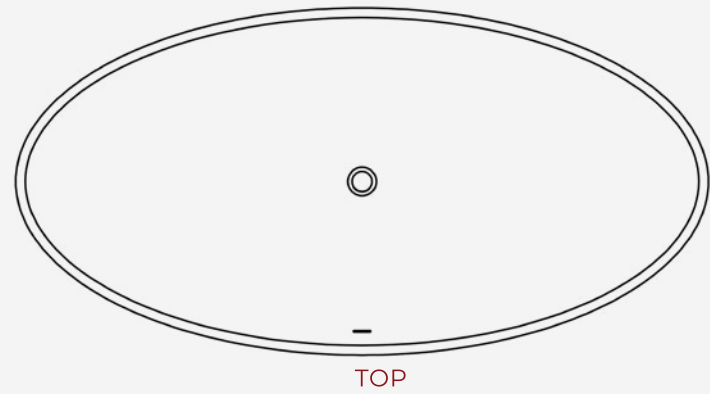

TOP

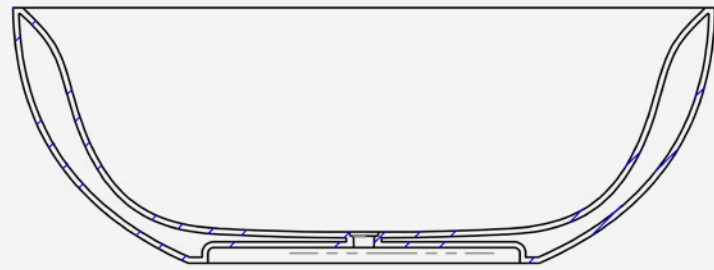

FRONT

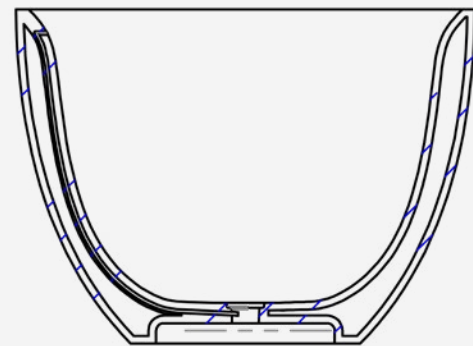

SIDE



JULIA

COLLECTION

COLLECTION:

Material:

Finish:

Dimension:

Weight:

Depth to Overflow:

Water Capacity:

Available Options:

JULIA / SOPH-JIT

Mineral Glass Composite

Satin Honed Finished

1800mm x 900mm x 655mm

122 kg (268 lbs)

525 mm

371 L (98 GL)

Colour Dua

Pantone Matching

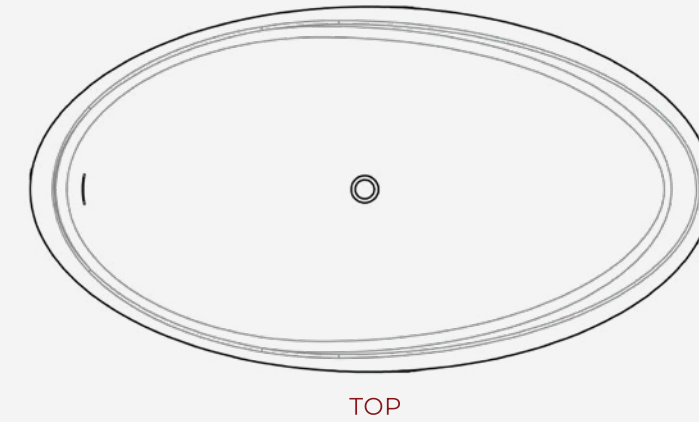

TOP

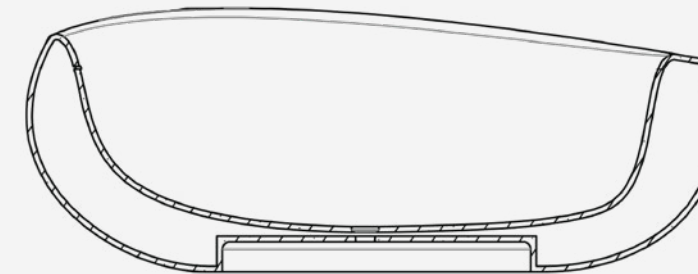

FRONT

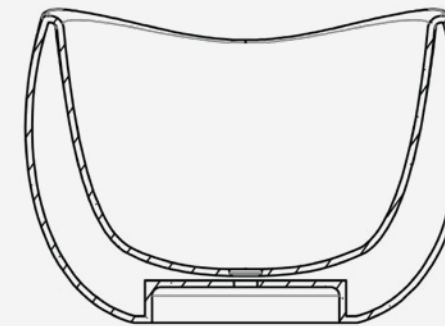

SIDE



MADISON

COLLECTION

COLLECTION:

Material:

Finish:

Dimension:

Weight:

Depth to Overflow:

Water Capacity:

Available Options:

MADISON / SOPH-MIT

Mineral Glass Composite

Satin Honed Finished

1839mm x 984mm x 700mm

148 kg (326 lbs)

418 mm

291 L (77 GL)

Colour Dua

Pantone Matching



MARINA

COLLECTION

COLLECTION: MARINA / SOPH-M2T

Material: Mineral Glass Composite
 Finish: Satin Honed Finished
 Dimension: 1780mm x 1020mm x 657mm
 Weight: 134 kg (295 lbs)
 Depth to Overflow: 387 mm
 Water Capacity: 310 L (82 GL)
 Available Options: Colour Dua
 Pantone Matching

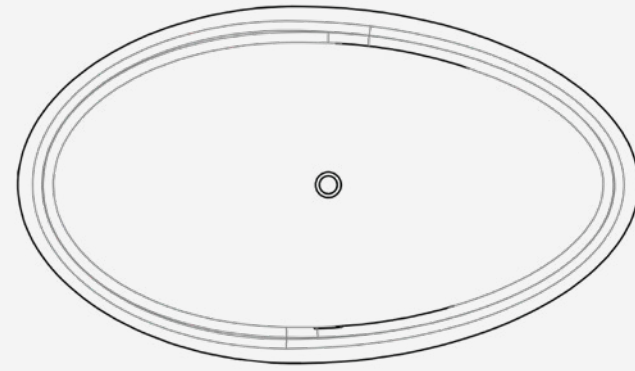

TOP

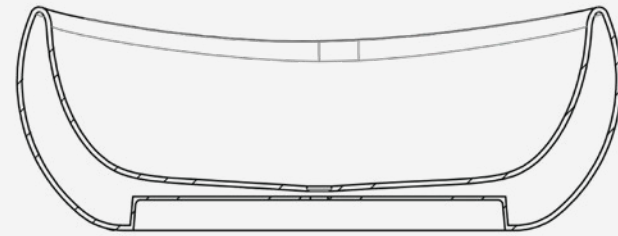

FRONT

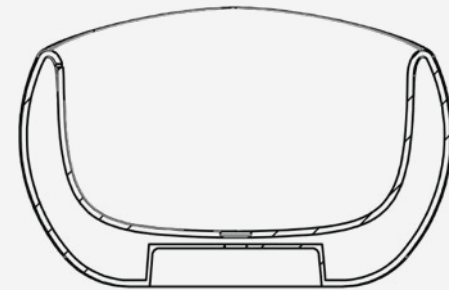

SIDE



MARCELA

COLLECTION

COLLECTION: MARCELA / SOPH-M3T

Material: Mineral Glass Composite
 Finish: Satin Honed Finished
 Dimension: 1840mm x 1020mm x 625mm
 Weight: 141 kg (310 lbs)
 Depth to Overflow: 357 mm
 Water Capacity: 212 L (56 GL)
 Available Options: Colour Dua
 Pantone Matching

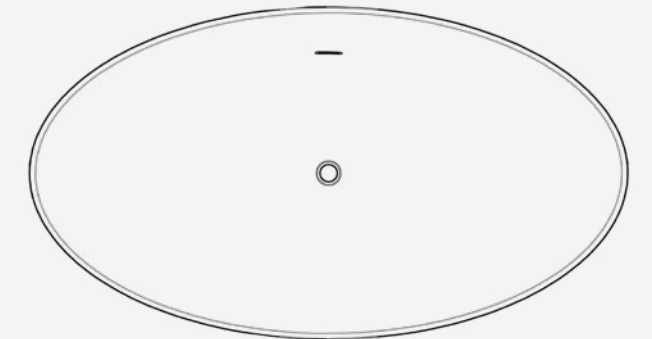

TOP

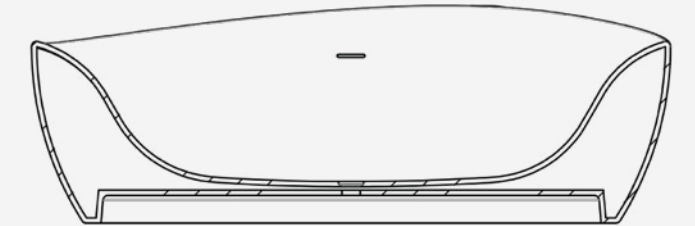

FRONT

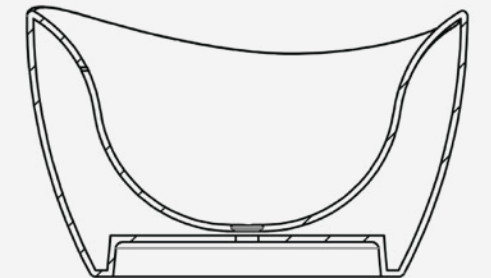

SIDE

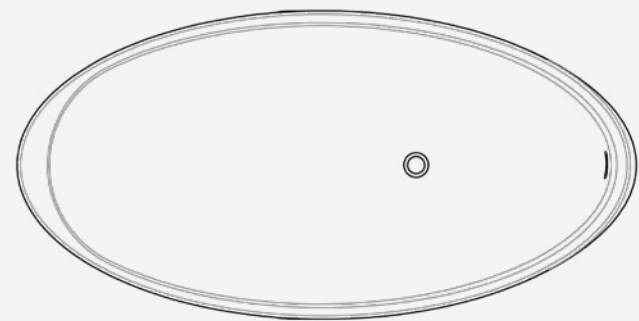

TOP

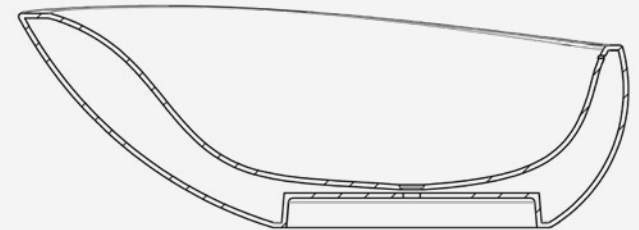

FRONT

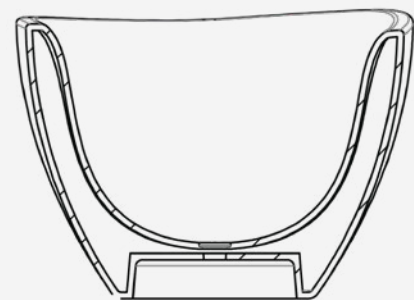

SIDE



MIA COLLECTION

COLLECTION:	MIA / SOPH-M4T
Material:	Mineral Glass Composite
Finish:	Satin Honed Finished
Dimension:	1848mm x 920mm x 670mm
Weight:	126 kg (278 lbs)
Depth to Overflow:	382 mm
Water Capacity:	192 L (50 GL)
Available Options:	Colour Dua Pantone Matching

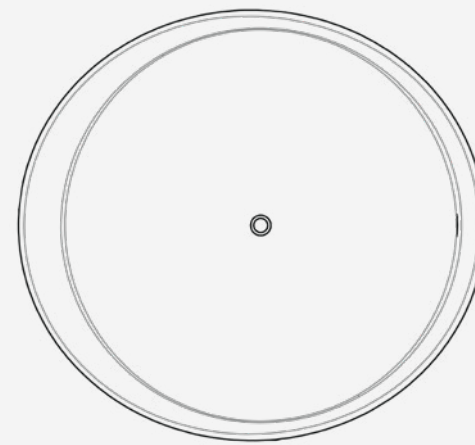

TOP

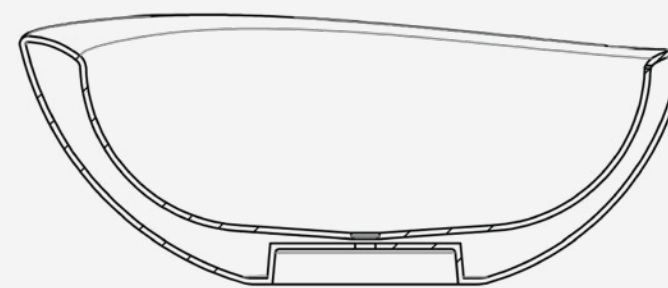

FRONT

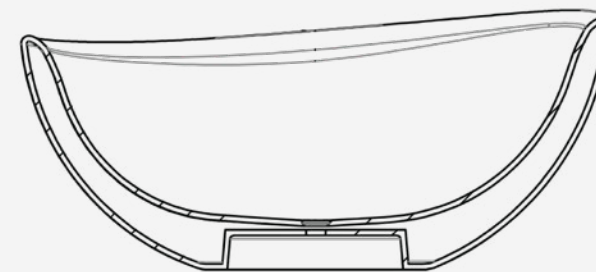

SIDE



MIKAYLA COLLECTION

COLLECTION:	MIKAYLA / SOPH-M5T
Material:	Mineral Glass Composite
Finish:	Satin Honed Finished
Dimension:	1692mm x 1556mm x 684mm
Weight:	158 kg (348 lbs)
Depth to Overflow:	415 mm
Water Capacity:	387 L (102 GL)
Available Options:	Colour Dua Pantone Matching

COLLECTION: MASON / SOPH-M6T
 Material: Mineral Glass Composite
 Finish: Satin Honed Finished
 Dimension: 1705mm x 941mm x 580mm
 Weight: 132 kg (291 lbs)
 Depth to Overflow: 410 mm
 Water Capacity: 273 L (72 GL)
 Available Options: Colour Dua
 Pantone Matching

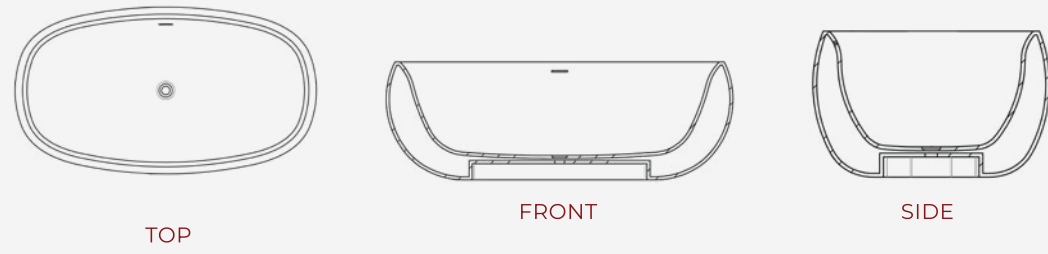

MASON COLLECTION



COLLECTION: MASON / SOPH-M6TL (Large)
 Material: Mineral Glass Composite
 Finish: Satin Honed Finished
 Dimension: 1903mm x 1101mm x 600mm
 Weight: 166 kg (365 lbs)
 Depth to Overflow: 430 mm
 Water Capacity: 375 L (99 GL)
 Available Options: Colour Dua
 Pantone Matching

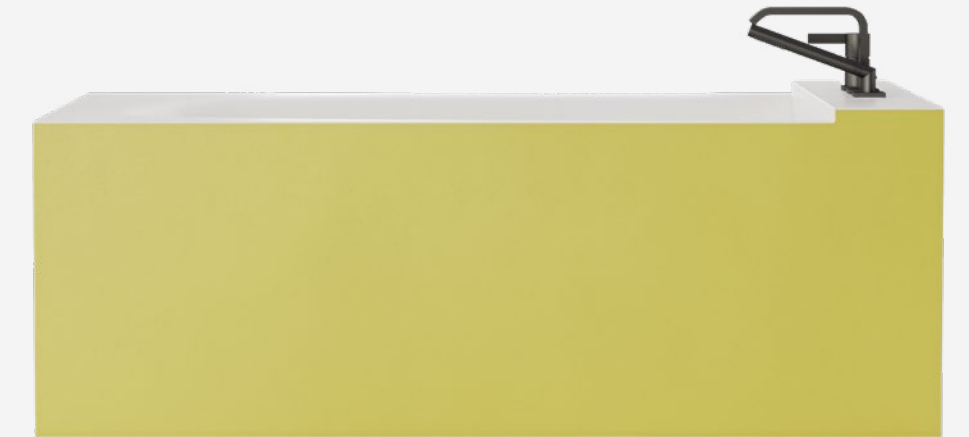
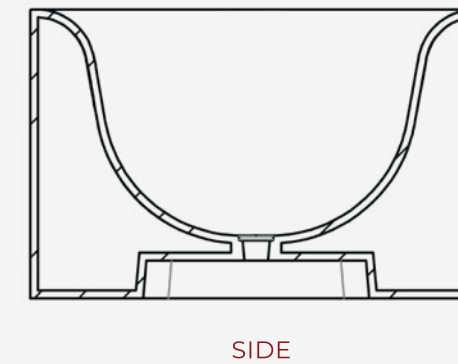
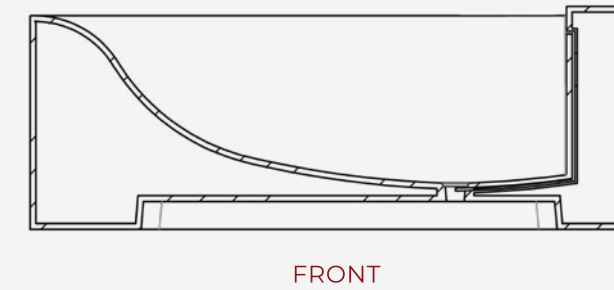
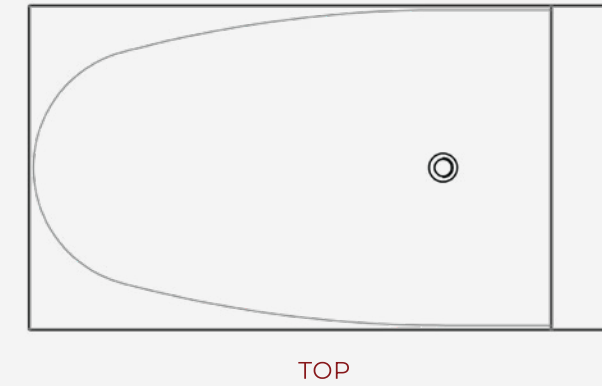
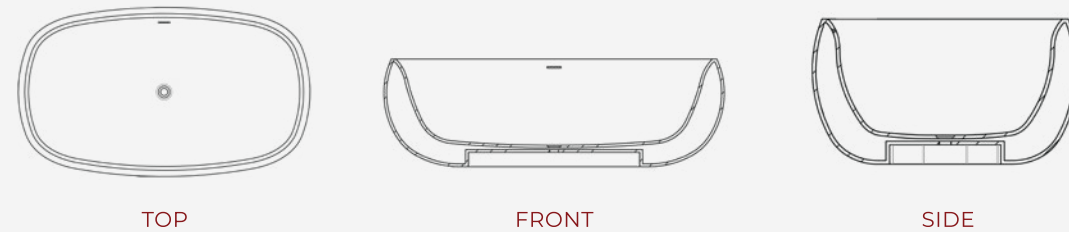

MAREA COLLECTION

COLLECTION: MAREA / SOPH-M7T
 Material: Mineral Glass Composite
 Finish: Satin Honed Finished
 Dimension: 1676mm x 914mm x 610mm
 Weight: 163 kg (360 lbs)
 Depth to Overflow: 410 mm
 Water Capacity: 205 L (54 GL)
 Available Options: Colour Dua
 Pantone Matching

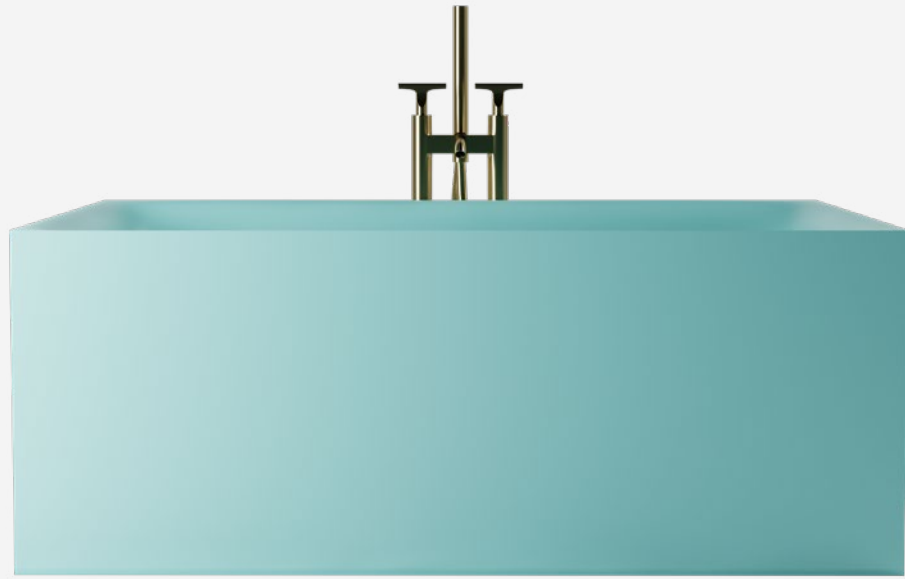

NOBLE

COLLECTION

COLLECTION: NOBLE / SOPH-NIT

Material: Mineral Glass Composite

Finish: Satin Honed Finished

Dimension: 1525mm x 780mm x 600mm

Weight: 137 kg (302 lbs)

Depth to Overflow: 419 mm

Water Capacity: 287 L (75 GL)

Available Options: Colour Dua
Pantone Matching

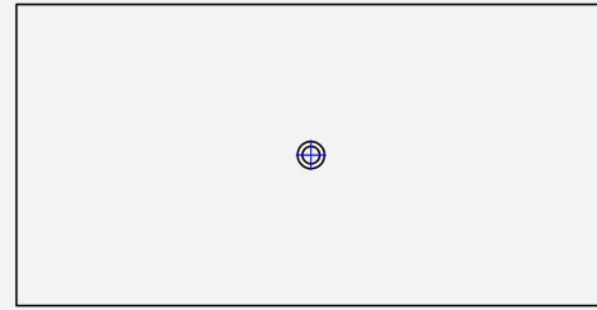

TOP

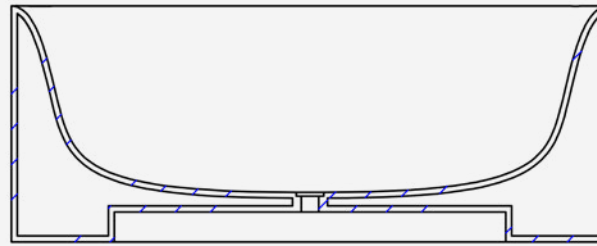

FRONT

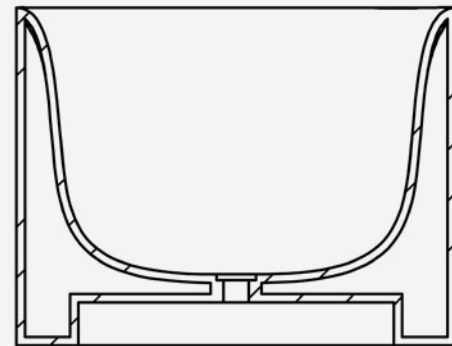

SIDE



OLIVIA

COLLECTION

COLLECTION: OLIVIA / SOPH-OIT

Material: Mineral Glass Composite

Finish: Satin Honed Finished

Dimension: 1700mm x 900mm x 580mm

Weight: 131 kg (288 lbs)

Depth to Overflow: 400 mm

Water Capacity: 265 L (70 GL)

Available Options: Colour Dua
Pantone Matching

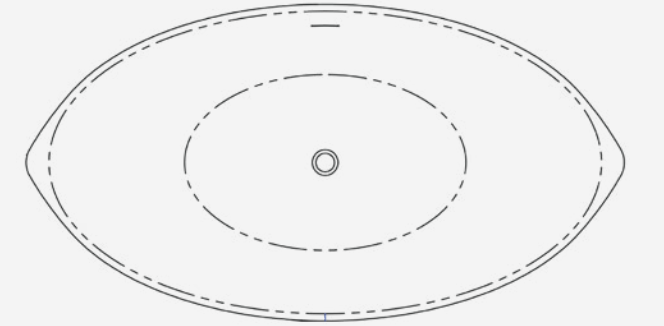

TOP

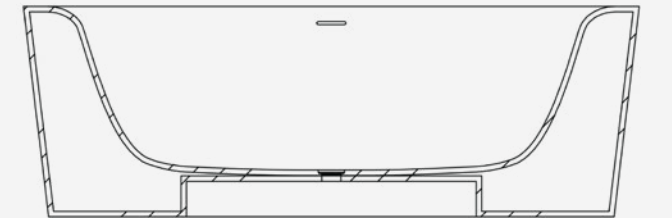

FRONT

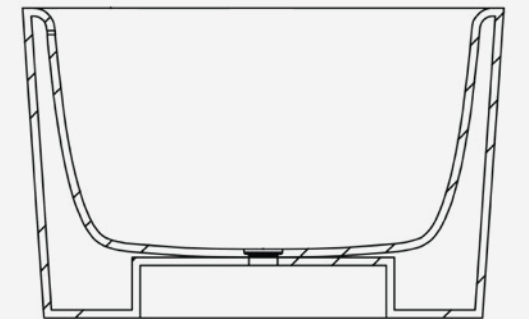

SIDE

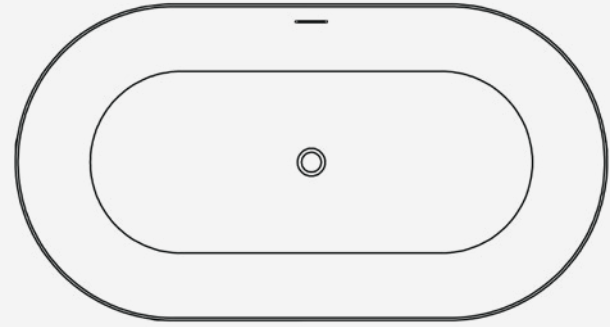

TOP

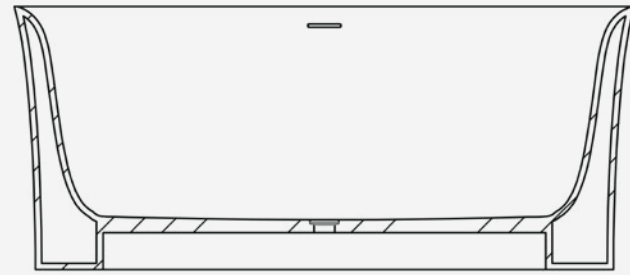

FRONT

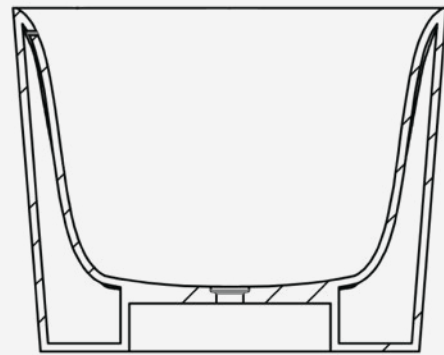

SIDE



PHOENIX COLLECTION

COLLECTION:

Material:

Finish:

Dimension:

Weight:

Depth to Overflow:

Water Capacity:

Available Options:

PHOENIX / SOPH-PIT

Mineral Glass Composite

Satin Honed Finished

1499mm x 800mm x 635mm

137 kg (302 lbs)

465 mm

303 L (80 GL)

Colour Dua

Pantone Matching

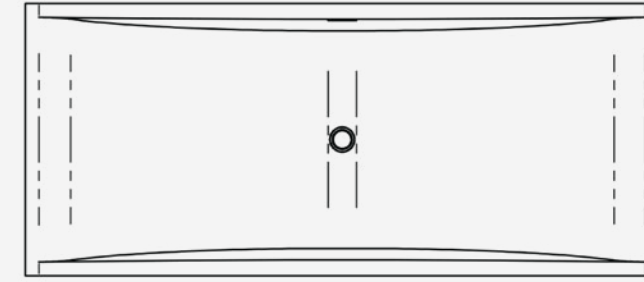

TOP

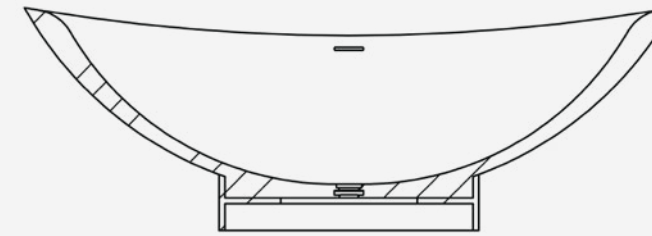

FRONT

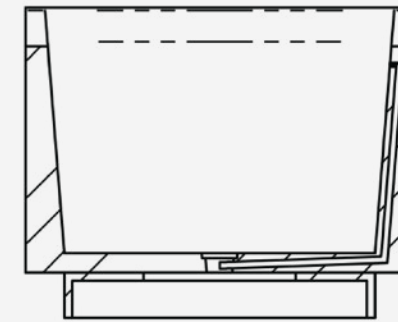

SIDE



SERENE COLLECTION

COLLECTION:

Material:

Finish:

Dimension:

Weight:

Depth to Overflow:

Water Capacity:

Available Options:

SERENE / SOPH-SIT

Mineral Glass Composite

Satin Honed Finished

1778mm x 762mm x 610mm

115 kg (253 lbs)

365 mm

239 L (63 GL)

Colour Dua

Pantone Matching



SILVA

COLLECTION

COLLECTION: SILVA / SOPH-S2T

Material: Mineral Glass Composite
Finish: Satin Honed Finished
Dimension: 1850mm x 840mm x 560mm
Weight: 99 kg (218 lbs)
Depth to Overflow: 379 mm
Water Capacity: 185 L (48 GL)
Available Options: Colour Dua
Pantone Matching

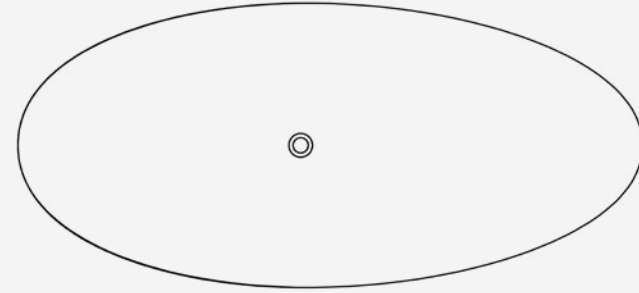

TOP

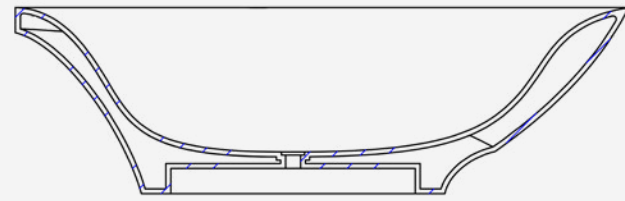

FRONT

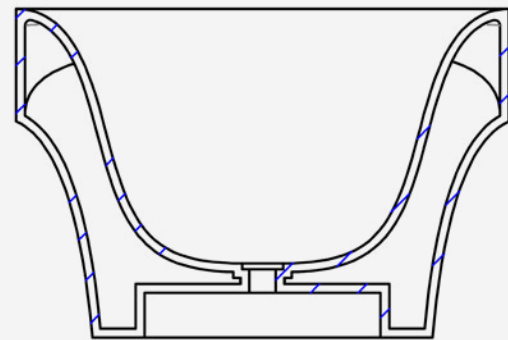

SIDE



OFURO

JAPANESE BATHTUB

THE COLLECTIONS:

CHRISTOPH 48

PHOENYX 49



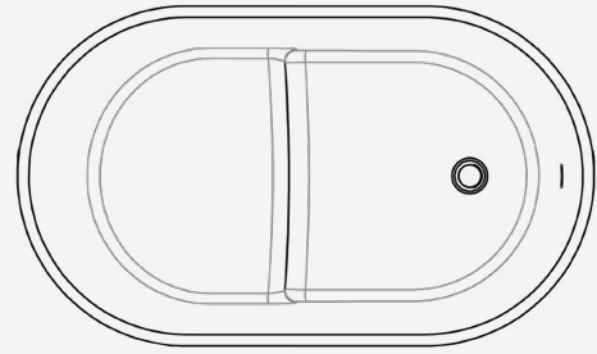

TOP

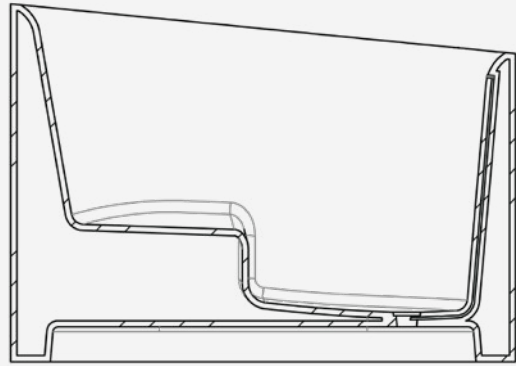

FRONT

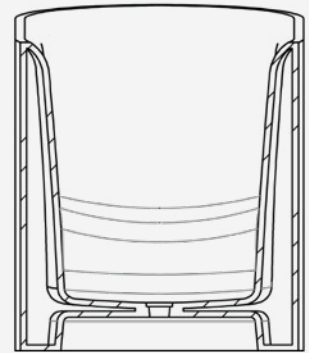

SIDE

COLLECTION:

Material:
Finish:
Dimension:
Weight:
Depth to Overflow:
Water Capacity:
Available Options:

CHRISTOPH / SOPH-CITO

Mineral Glass Composite
Satin Honed Finished
1295mm x 762mm x 914mm
148 kg (326 lbs)
600mm
269 L (71 GL)
Colour Dua
Pantone Matching

CHRISTOPH

COLLECTION

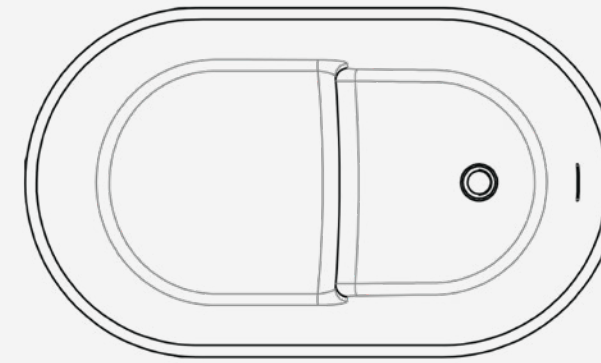

TOP

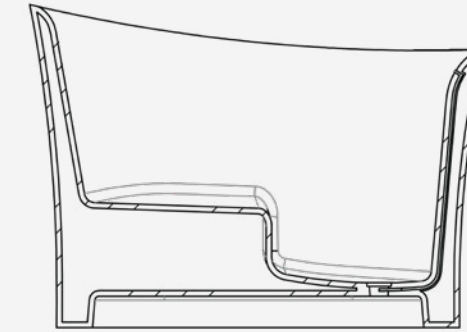

FRONT

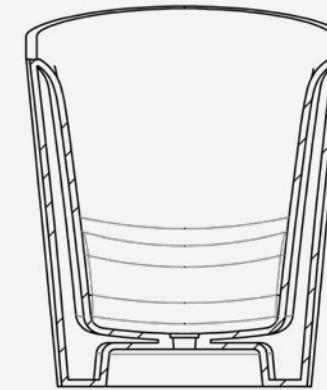

SIDE

COLLECTION:

Material:
Finish:
Dimension:
Weight:
Depth to Overflow:
Water Capacity:
Available Options:

PHOENYX / SOPH-PITO

Mineral Glass Composite
Satin Honed Finished
1295mm x 762mm x 914mm
129 kg (284 lbs)
595mm
201 L (53 GL)
Colour Dua
Pantone Matching

PHOENYX

COLLECTION



FREESTANDING BASIN

THE COLLECTIONS:

AHRI	54	ISABEL	58	MARCELA	62	OLIVIA	66
BRANDI	55	JULIA	59	MASON	63	PHOENYX	67
CHRISTOPH	56	MADISON	60	MAREA	64	SERENE	68
DANIELLE	57	MARINA	61	NOBLE	65	SILVA	69



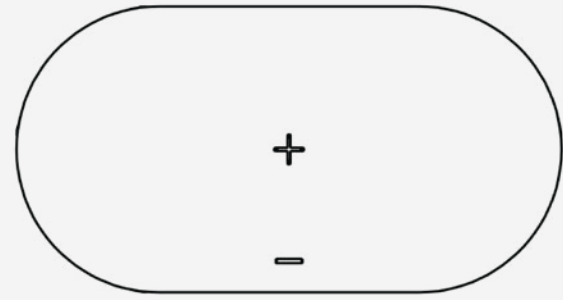

TOP

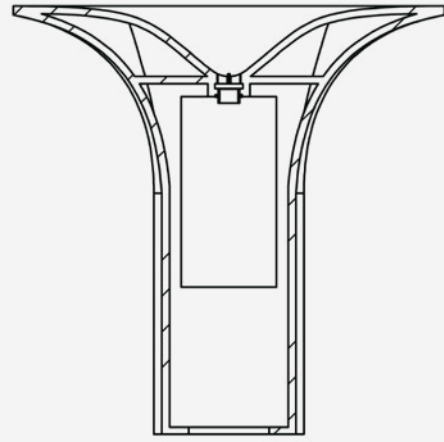

FRONT

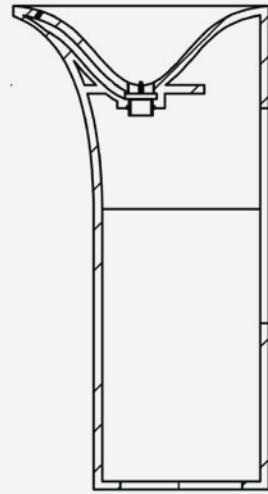

SIDE

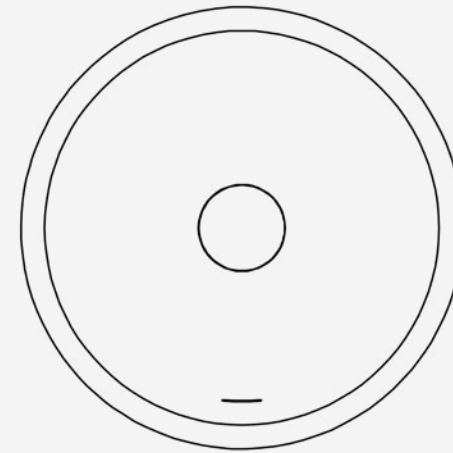

TOP

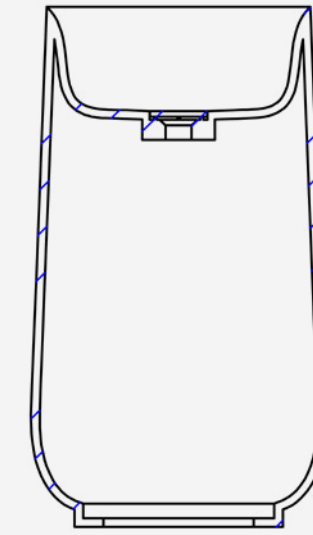

FRONT

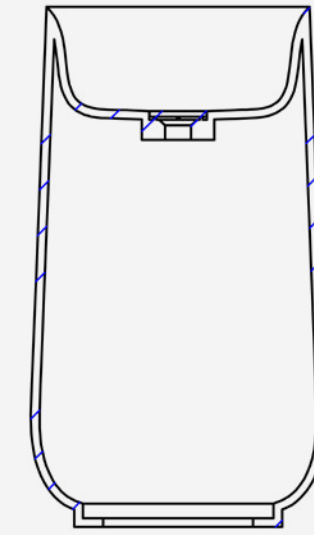

SIDE



COLLECTION:

Material:
Finish:
Dimension:
Weight:
Drain Opening:
Available Options:

AHRI / SOPH-A1FB

Mineral Glass Composite
Satin Honed Finished
920mm x 482mm x 914mm
27 kg (61 lbs)
SOPHSTONE + Drain
Colour Dua
Pantone Matching

AHRI
COLLECTION

* SOPHSTONE + Drain has an integrated 1-1/2" threaded P-trap adapter.
* Rear cutout for in-wall plumbing.



COLLECTION:

Material:
Finish:
Dimension:
Weight:
Drain Opening:
Available Options:

BRANDI / SOPH-B1FB

Mineral Glass Composite
Satin Honed Finished
510mm x 510mm x 900mm
36 kg (80 lbs)
Obscure Cover
Colour Dua
Pantone Matching

BRANDI
COLLECTION

* Obscure Cover requires a standard drop-in drain.
* Standard bottom cutout for in-floor plumbing.
* Optional rear cutout for in-wall plumbing.



COLLECTION: CHRISRTOPH / SOPH-C1FB

Material: Mineral Glass Composite
 Finish: Satin Honed Finished
 Dimension: 610mm x 406mm x 914mm
 Weight: 30 kg (68 lbs)
 Drain Opening: Obscure Cover
 Available Options: Colour Dua
 Pantone Matching

- * Obscure Cover requires a standard drop-in drain.
- * Standard bottom cutout for in-floor plumbing.
- * Optional rear cutout for in-wall plumbing.



COLLECTION: DANIEL / SOPH-D1FB

Material: Mineral Glass Composite
 Finish: Satin Honed Finished
 Dimension: 711mm x 457mm x 914mm
 Weight: 29 kg (64 lbs)
 Drain Opening: Obscure Cover
 Available Options: Colour Dua
 Pantone Matching

- * Obscure Cover requires a standard drop-in drain.
- * Standard bottom cutout for in-floor plumbing.
- * Optional rear cutout for in-wall plumbing.

CHRISTOPH COLLECTION

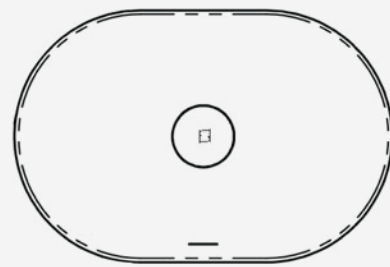

TOP

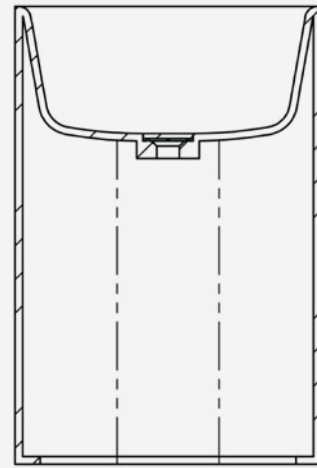

FRONT

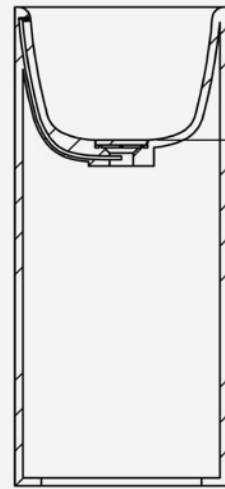

SIDE

DANIELLE COLLECTION

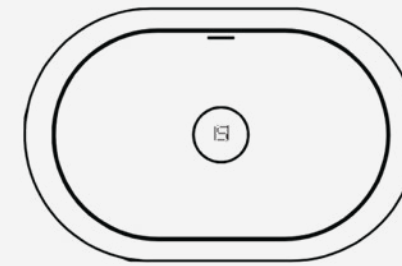

TOP

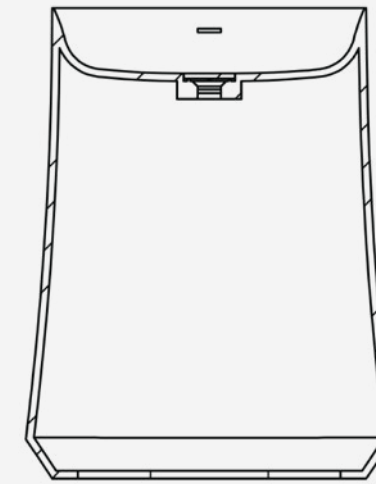

FRONT

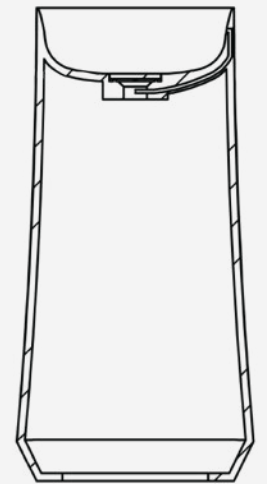

SIDE

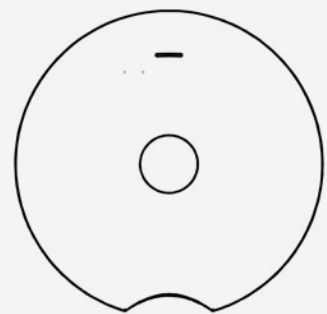

TOP

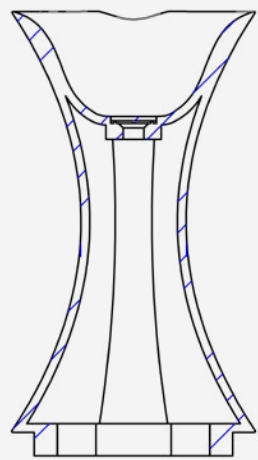

FRONT

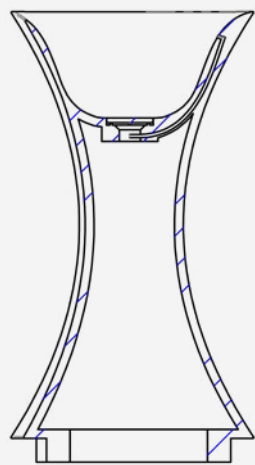

SIDE

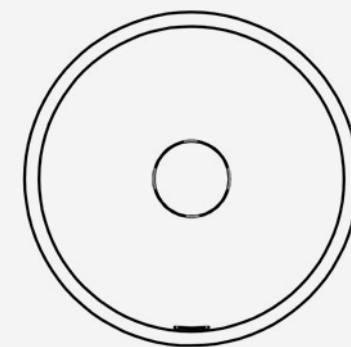

TOP

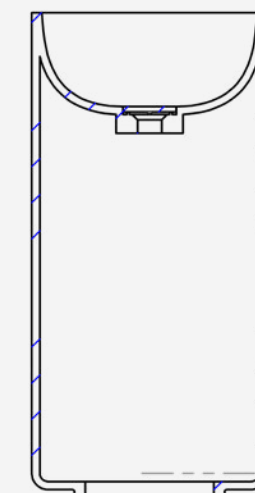

FRONT

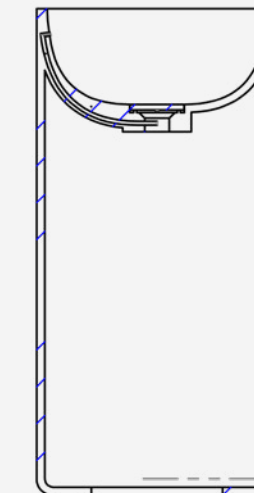

SIDE



COLLECTION:

ISABEL / SOPH-I1FB

Material: Mineral Glass Composite
 Finish: Satin Honed Finished
 Dimension: 533mm x 533mm x 964mm
 Weight: 40 kg (88 lbs)
 Drain Opening: Obscure Cover
 Available Options: Colour Dua
 Pantone Matching

ISABEL

COLLECTION

- * Obscure Cover requires a standard drop-in drain.
- * Standard bottom cutout for in-floor plumbing.
- * Optional rear cutout for in-wall plumbing.



COLLECTION:

JULIA / SOPH-J1FB

Material: Mineral Glass Composite
 Finish: Satin Honed Finished
 Dimension: 440mm x 440mm x 900mm
 Weight: 34 kg (78 lbs)
 Drain Opening: Obscure Cover
 Available Options: Colour Dua
 Pantone Matching

JULIA

COLLECTION

- * Obscure Cover requires a standard drop-in drain.
- * Standard bottom cutout for in-floor plumbing.
- * Optional rear cutout for in-wall plumbing.



COLLECTION: MADISON / SOPH-M1FB
Material: Mineral Glass Composite
Finish: Satin Honed Finished
Dimension: 631mm x 476mm x 870mm
Weight: 30 kg (67 lbs)
Drain Opening: Obscure Cover
Available Options: Colour Dua
 Pantone Matching

- * Obscure Cover requires a standard drop-in drain.
- * Standard bottom cutout for in-floor plumbing.
- * Optional rear cutout for in-wall plumbing.

MADISON COLLECTION



COLLECTION: MARINA / SOPH-M2FB
Material: Mineral Glass Composite
Finish: Satin Honed Finished
Dimension: 628mm x 428mm x 883mm
Weight: 30 kg (67 lbs)
Drain Opening: Obscure Cover
Available Options: Colour Dua
 Pantone Matching

- * Obscure Cover requires a standard drop-in drain.
- * Standard bottom cutout for in-floor plumbing.
- * Optional rear cutout for in-wall plumbing.

MARINA COLLECTION

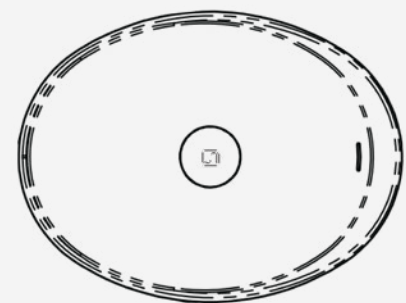

TOP

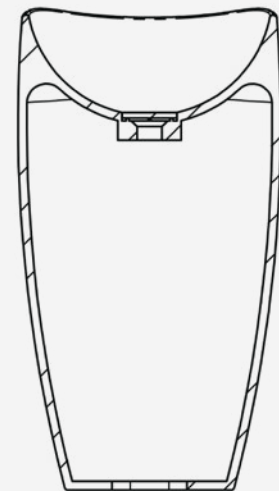

FRONT

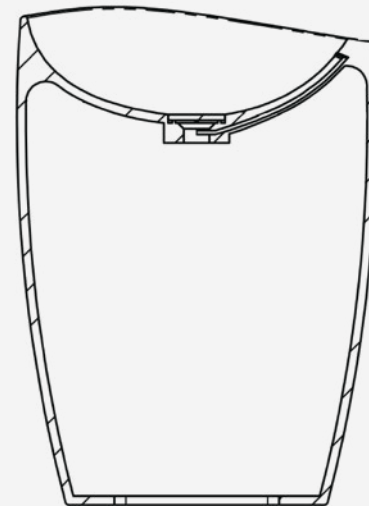

SIDE

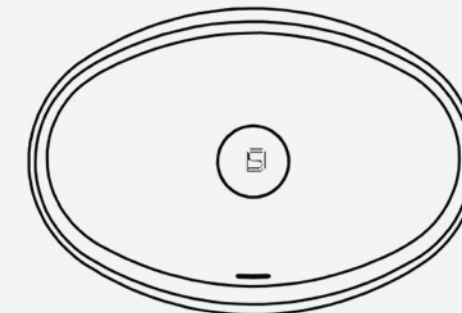

TOP

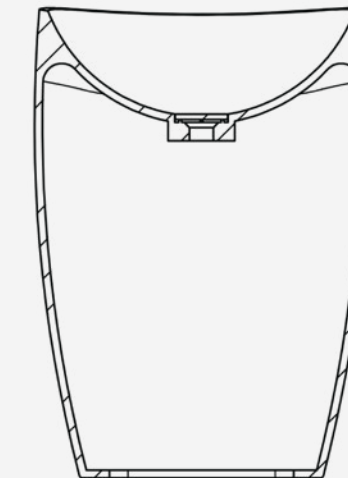

FRONT

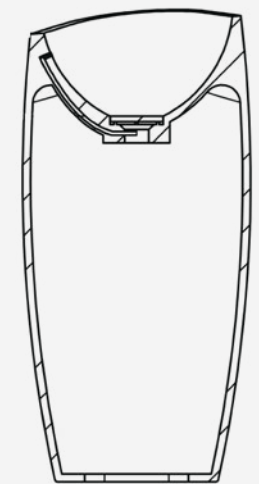

SIDE

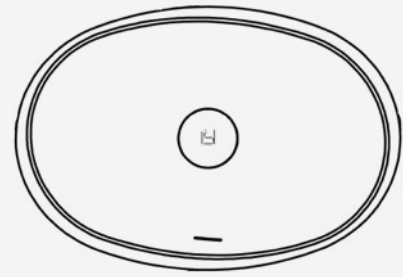

TOP

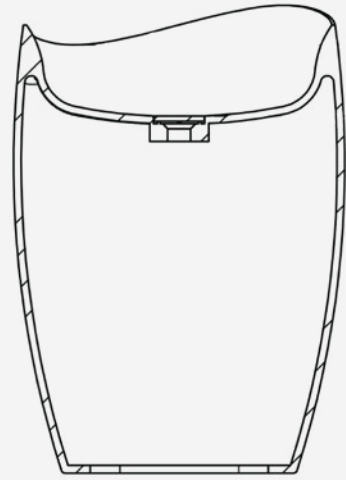

FRONT

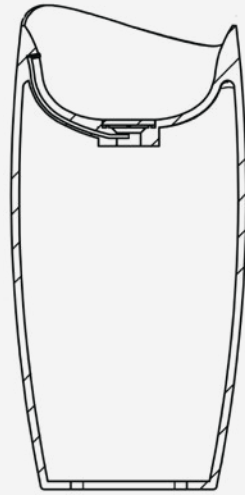

SIDE

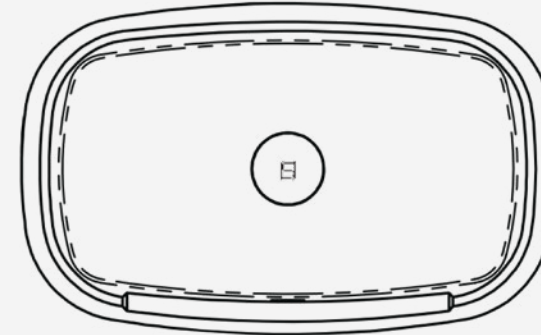

TOP

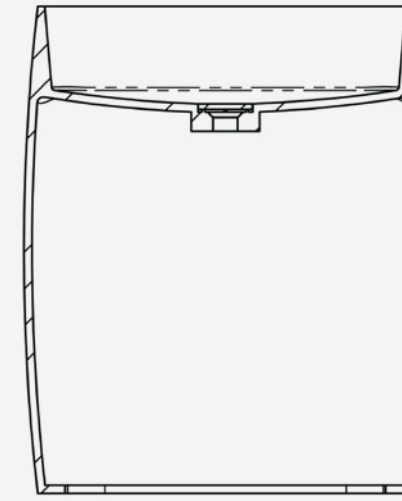

FRONT

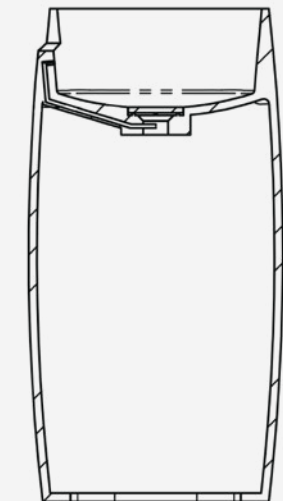

SIDE



COLLECTION: MARCELA / SOPH-M3FB

Material: Mineral Glass Composite

Finish: Satin Honed Finished

Dimension: 648mm x 444mm x 914mm

Weight: 28 kg (62 lbs)

Drain Opening: Obscure Cover

Available Options: Colour Dua
Pantone Matching

- * Obscure Cover requires a standard drop-in drain.
- * Standard bottom cutout for in-floor plumbing.
- * Optional rear cutout for in-wall plumbing.

MARCELA COLLECTION



COLLECTION: MASON / SOPH-M6FB

Material: Mineral Glass Composite

Finish: Satin Honed Finished

Dimension: 737mm x 457mm x 889mm

Weight: 34 kg (76 lbs)

Drain Opening: Obscure Cover

Available Options: Colour Dua
Pantone Matching

- * Obscure Cover requires a standard drop-in drain.
- * Standard bottom cutout for in-floor plumbing.
- * Optional rear cutout for in-wall plumbing.

MASON COLLECTION



COLLECTION: MAREA / SOPH-M7FB

Material: Mineral Glass Composite

Finish: Satin Honed Finished

Dimension: 680mm x 550mm x 900mm

Weight: 42 kg (93 lbs)

Drain Opening: Evanesce

Available Options: Colour Dua
Pantone Matching

MAREA COLLECTION

- * Evanesce has an integrated 1-1/2" threaded P-trap adapter.
- * Standard bottom cutout for in-floor plumbing.
- * Optional rear cutout for in-wall plumbing.



COLLECTION: NOBLE / SOPH-N1FB

Material: Mineral Glass Composite

Finish: Satin Honed Finished

Dimension: 510mm x 510mm x 900mm

Weight: 49 kg (108 lbs)

Drain Opening: Obscure Cover

Available Options: Colour Dua
Pantone Matching

NOBLE COLLECTION

- * Obscure Cover requires a standard drop-in drain.
- * Standard bottom cutout for in-floor plumbing.
- * Optional rear cutout for in-wall plumbing.

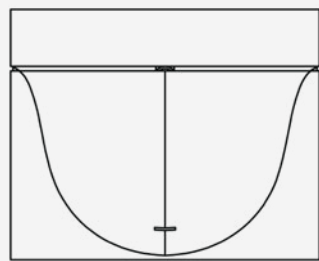

TOP

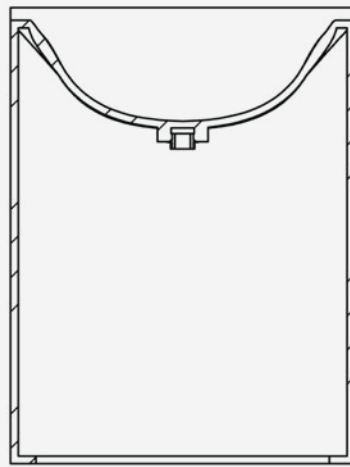

FRONT

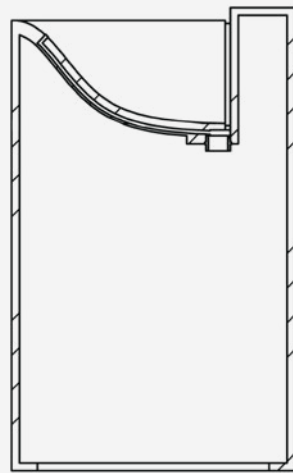

SIDE

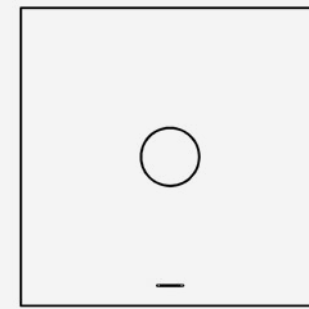

TOP

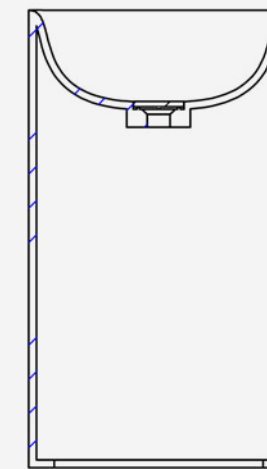

FRONT

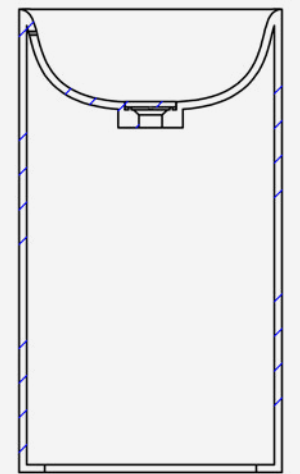

SIDE

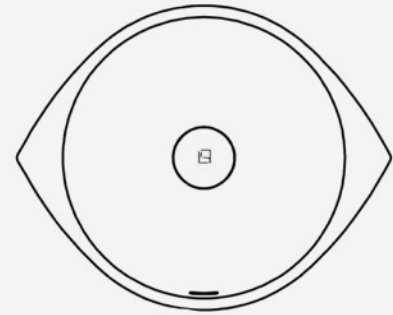

TOP

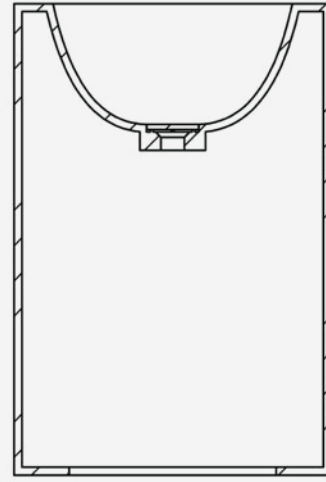

FRONT

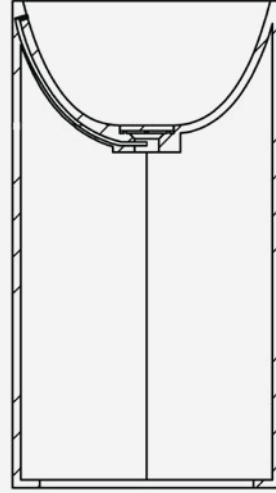

SIDE

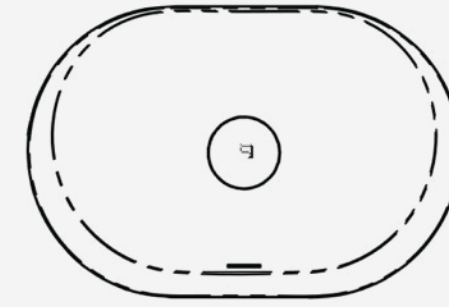

TOP

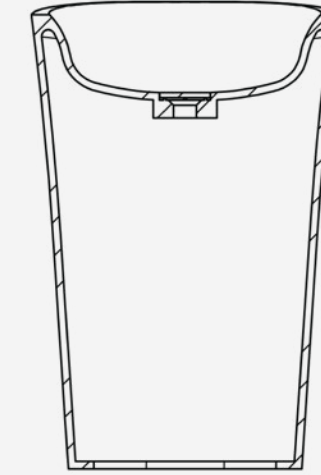

FRONT

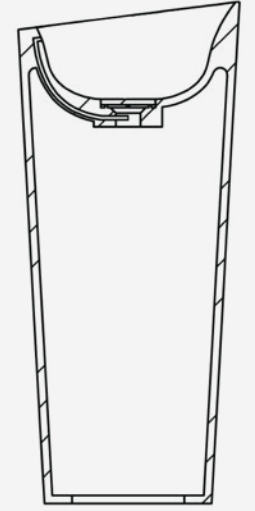

SIDE



COLLECTION:

OLIVIA / SOPH-O1FB

Material: Mineral Glass Composite
 Finish: Satin Honed Finished
 Dimension: 606mm x 495mm x 900mm
 Weight: 29 kg (64 lbs)
 Drain Opening: Obscure Cover
 Available Options: Colour Dua
 Pantone Matching

OLIVIA

COLLECTION

- * Obscure Cover requires a standard drop-in drain.
- * Standard bottom cutout for in-floor plumbing.
- * Optional rear cutout for in-wall plumbing.



COLLECTION:

PHOENIX / SOPH-P1FB

Material: Mineral Glass Composite
 Finish: Satin Honed Finished
 Dimension: 602mm x 403mm x 889mm
 Weight: 25 kg (56 lbs)
 Drain Opening: Obscure Cover
 Available Options: Colour Dua
 Pantone Matching

PHOENIX

COLLECTION

- * Obscure Cover requires a standard drop-in drain.
- * Standard bottom cutout for in-floor plumbing.
- * Optional rear cutout for in-wall plumbing.



COLLECTION:

Material:
Finish:
Dimension:
Weight:
Drain Opening:
Available Options:

SERENE / SOPH-S1FB

Mineral Glass Composite
Satin Honed Finished
750mm x 460mm x 910mm
41 kg (92 lbs)
Obscure Cover
Colour Dua
Pantone Matching

SERENE
COLLECTION

- * Obscure Cover requires a standard drop-in drain.
- * Standard bottom cutout for in-floor plumbing.
- * Optional rear cutout for in-wall plumbing.

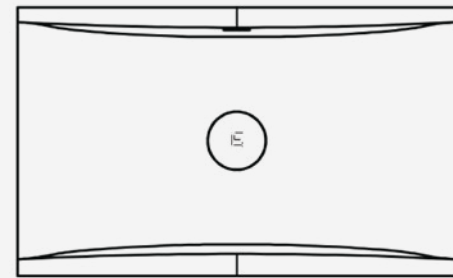

TOP

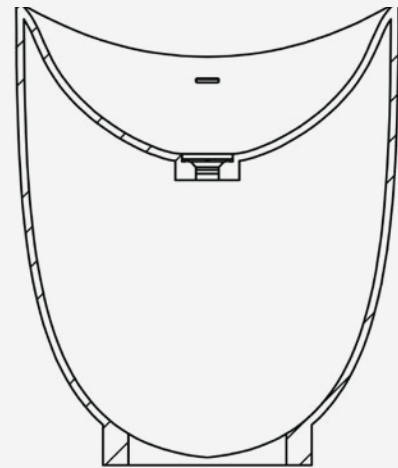

FRONT

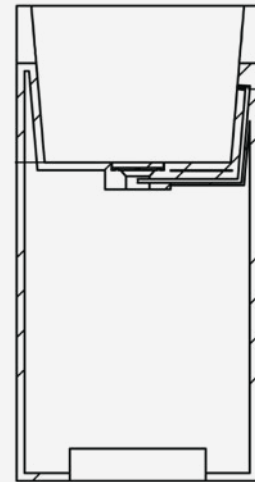

SIDE



COLLECTION:

Material:
Finish:
Dimension:
Weight:
Drain Opening:
Available Options:

SILVA / SOPH-S2FB

Mineral Glass Composite
Satin Honed Finished
580mm x 580mm x 914mm
25 kg (55 lbs)
Obscure Cover
Colour Dua
Pantone Matching

SILVA
COLLECTION

- * Obscure Cover requires a standard drop-in drain.
- * Standard bottom cutout for in-floor plumbing.
- * Optional rear cutout for in-wall plumbing.

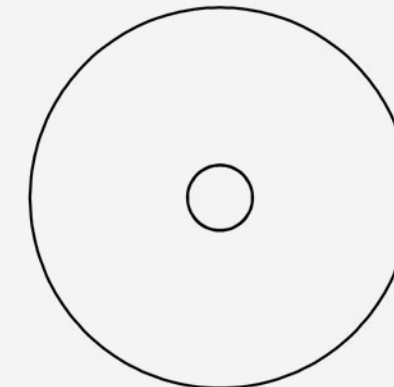

TOP

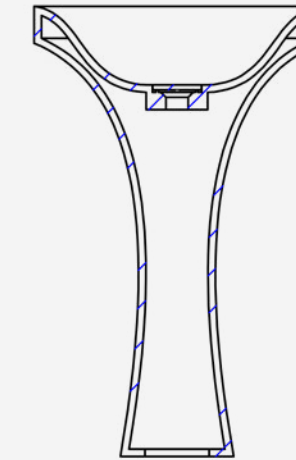

FRONT

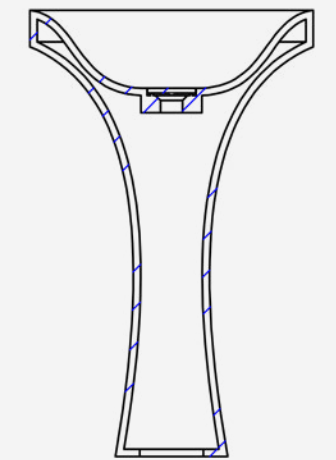

SIDE

VESSEL SINK

THE COLLECTIONS:

AHRI	72	ELIZABETH	76	MARINA	80	MASON	84	PHOENYX	88
BRANDI	73	ISABEL	77	MARCELA	81	MAREA	85	SERENE	89
CHRISTOPH	74	JULIA	78	MIA	82	NOBLE	86	SILVA	90
DANIELLE	75	MADISON	79	MIKAYLA	83	OLIVIA	87		

COLLECTION:

AHRI / SOPH-A1V

Material: Mineral Glass Composite
 Finish: Satin Honed Finished
 Dimension: 600mm x 380mm x 180mm
 Weight: 8 kg (17 lbs)
 Drain Opening: SOPHSTONE x drain
 Available Options: Colour Dua
 Pantone Matching

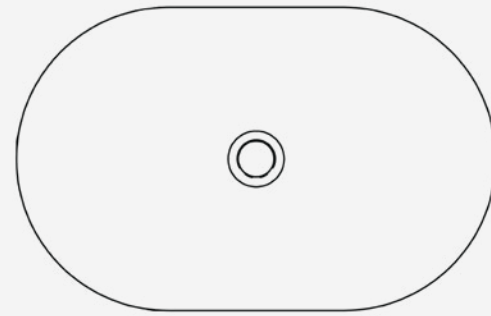

TOP

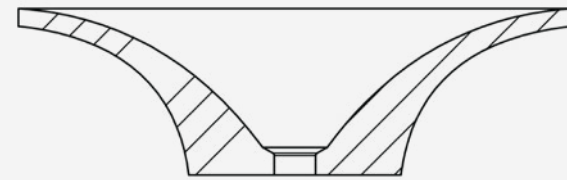

FRONT

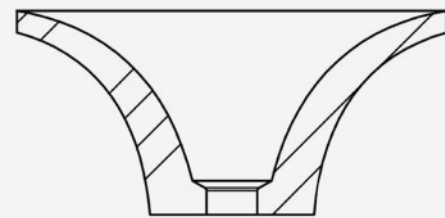

SIDE

AHRI

COLLECTION



COLLECTION:

BRANDI / SOPH-B1V

Material: Mineral Glass Composite
 Finish: Satin Honed Finished
 Dimension: 410mm x 410mm x 175mm
 Weight: 10 kg (22 lbs)
 Drain Opening: Obscure Cover
 Available Options: Colour Dua
 Pantone Matching

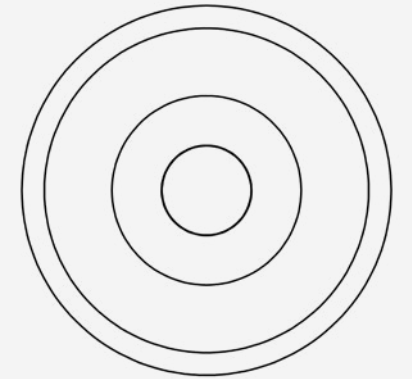

TOP

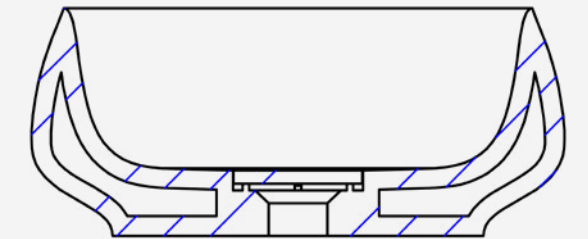

FRONT

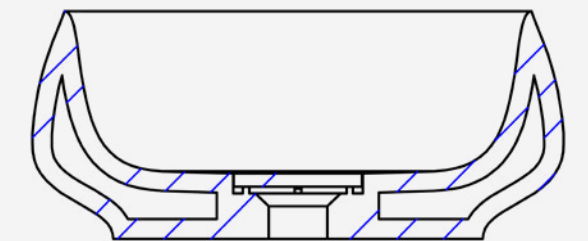

SIDE

BRANDI

COLLECTION



* Obscure Cover requires a standard drop-in drain.

① **COLLECTION:** CHRISTOPH / SOPH-C1V (Short)

Material: Mineral Glass Composite
Finish: Satin Honed Finished
Dimension: 610mm x 381mm x 138mm
Weight: 14 kg (30 lbs)
Drain Option: Obscure Cover
Available Options: Colour Dua
Pantone Matching

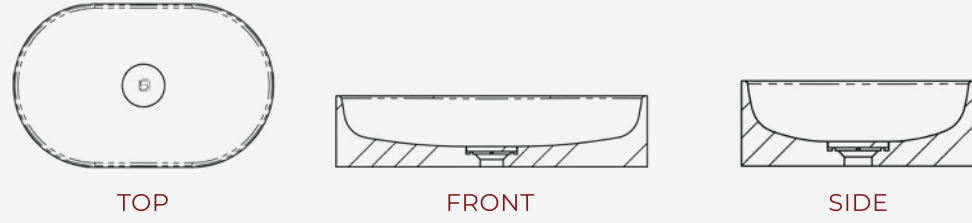

* Obscure Cover requires a standard drop-in drain.



①

CHRISTOPH

COLLECTION



②

① **COLLECTION:** DANIELLE / SOPH-D1V (Short)

Material: Mineral Glass Composite
Finish: Satin Honed Finished
Dimension: 648mm x 406mm x 110mm
Weight: 17 kg (38 lbs)
Drain Option: Obscure Cover
Available Options: Colour Dua
Pantone Matching

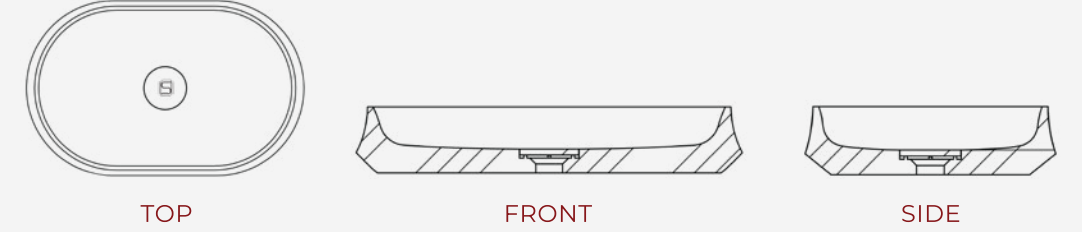

* Obscure Cover requires a standard drop-in drain.



①

DANIELLE

COLLECTION



②

② **COLLECTION:** CHRISTOPH / SOPH-C1VT (Tall)

Material: Mineral Glass Composite
Finish: Satin Honed Finished
Dimension: 610mm x 381mm x 215mm
Weight: 17 kg (38 lbs)
Drain Option: Obscure Cover
Available Options: Colour Dua
Pantone Matching

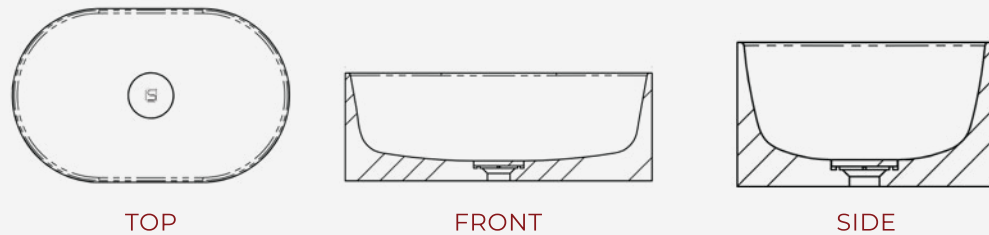

* Obscure Cover requires a standard drop-in drain.

② **COLLECTION:** DANIELLE / SOPH-D1VT (Tall)

Material: Mineral Glass Composite
Finish: Satin Honed Finished
Dimension: 660mm x 406mm x 215mm
Weight: 19 kg (43 lbs)
Drain Option: Obscure Cover
Available Options: Colour Dua
Pantone Matching

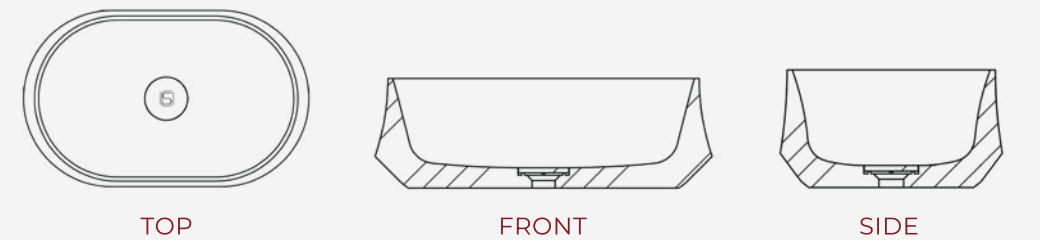

* Obscure Cover requires a standard drop-in drain.

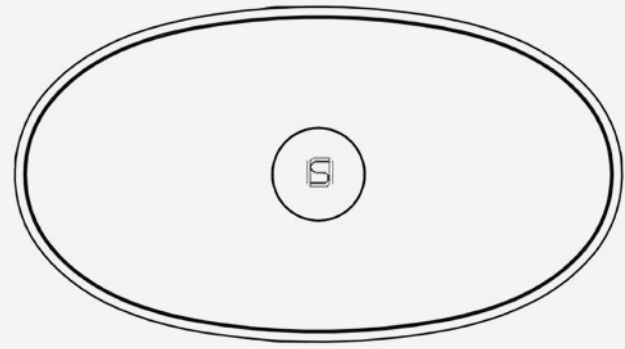

TOP

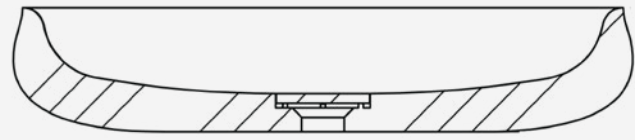

FRONT

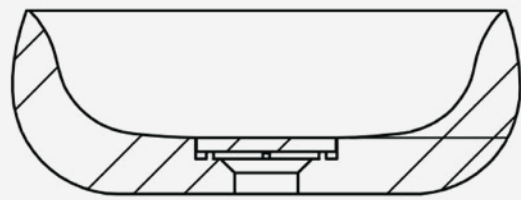

SIDE

COLLECTION:

Material:
Finish:
Dimension:
Weight:
Drain Opening:
Available Options:

ELIZABETH / SOPH-E1V

Mineral Glass Composite
Satin Honed Finished
655mm x 360mm x 130mm
12 kg (25 lbs)
Obscure Cover
Colour Dua
Pantone Matching

* Obscure Cover requires a standard drop-in drain.

ELIZABETH

COLLECTION

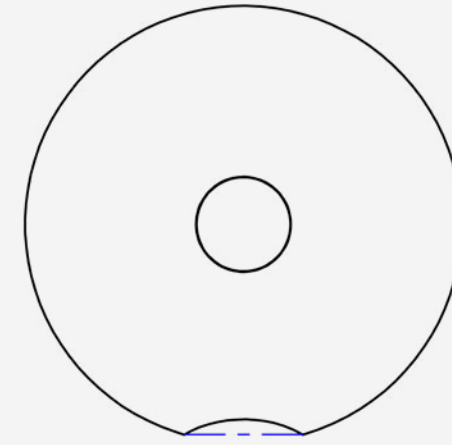

TOP

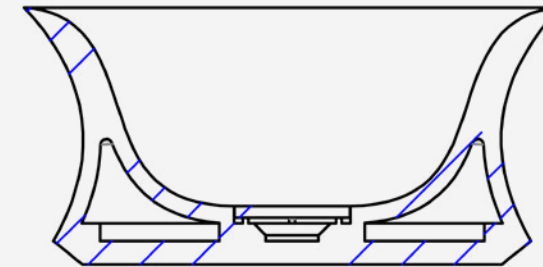

FRONT

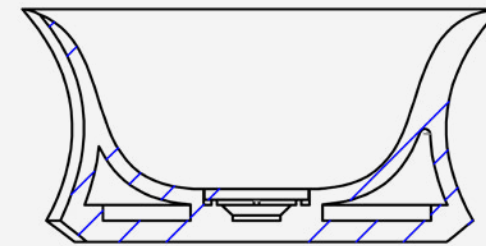

SIDE

COLLECTION:

Material:
Finish:
Dimension:
Weight:
Drain Opening:
Available Options:

ISABEL / SOPH-I1V

Mineral Glass Composite
Satin Honed Finished
460mm x 460mm x 220mm
14 kg (31 lbs)
Obscure Cover
Colour Dua
Pantone Matching

* Obscure Cover requires a standard drop-in drain.

ISABEL

COLLECTION



COLLECTION:

JULIA / SOPH-J1V

Material: Mineral Glass Composite
 Finish: Satin Honed Finished
 Dimension: 400mm x 400mm x 165mm
 Weight: 10 kg (22 lbs)
 Drain Opening: Obscure Cover
 Available Options: Colour Dua
 Pantone Matching

* Obscure Cover requires a standard drop-in drain.

JULIA

COLLECTION

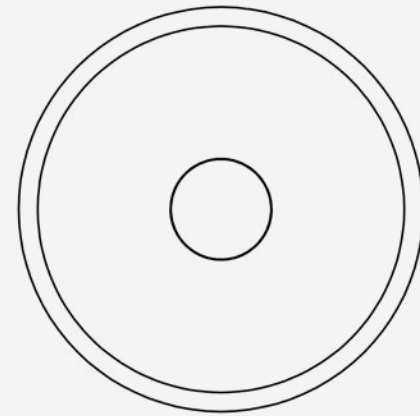

TOP

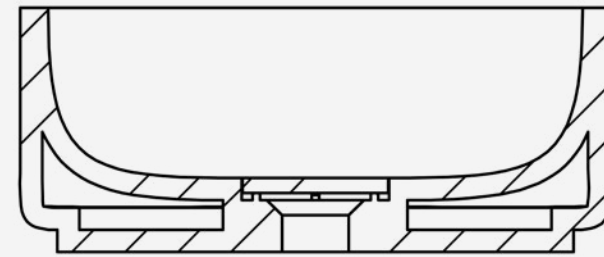

FRONT

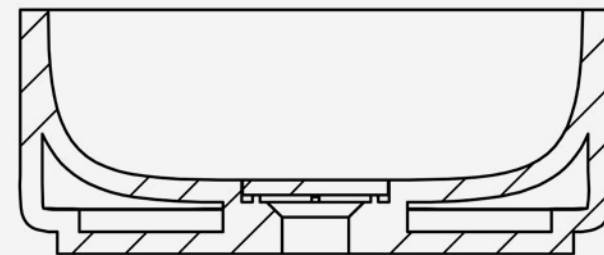

SIDE

COLLECTION:

MADISON / SOPH-M1V

Material: Mineral Glass Composite
 Finish: Satin Honed Finished
 Dimension: 573mm x 391mm x 180mm
 Weight: 14 kg (30 lbs)
 Drain Opening: Obscure Cover
 Available Options: Colour Dua
 Pantone Matching

* Obscure Cover requires a standard drop-in drain.

MADISON

COLLECTION

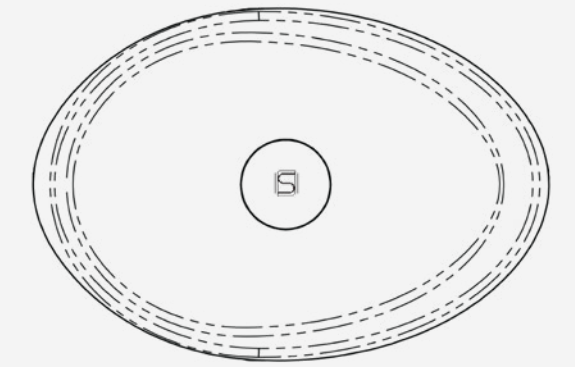

TOP

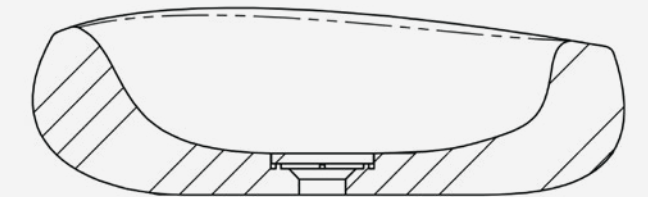

FRONT

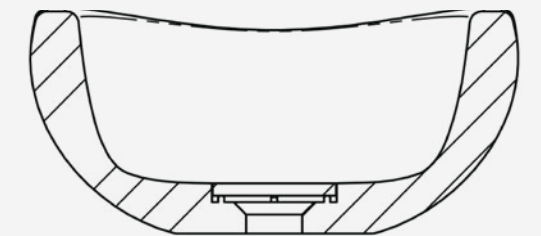

SIDE

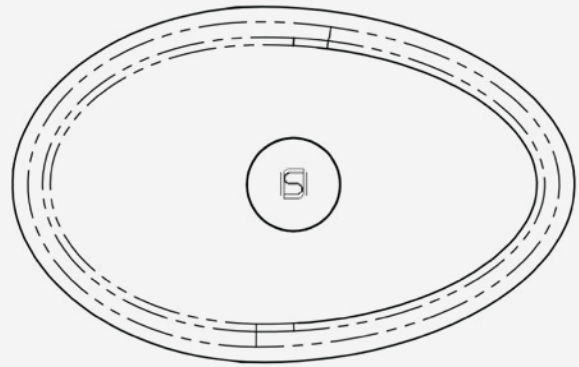

TOP

COLLECTION:

Material:
Finish:
Dimension:
Weight:
Drain Opening:
Available Options:

MARINA / SOPH-M2V

Mineral Glass Composite
Satin Honed Finished
600mm x 380mm x 174mm
15 kg (32 lbs)
Obscure Cover
Colour Dua
Pantone Matching

* Obscure Cover requires a standard drop-in drain.

MARINA
COLLECTION

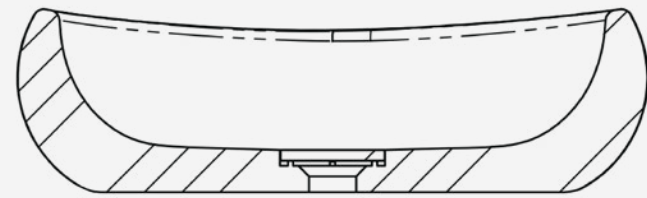

FRONT

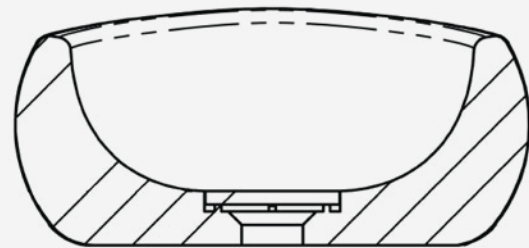

SIDE

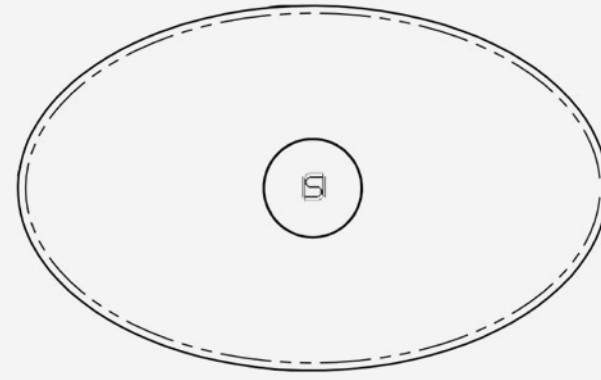

TOP

COLLECTION:

Material:
Finish:
Dimension:
Weight:
Drain Opening:
Available Options:

MARCELA / SOPH-M3V

Mineral Glass Composite
Satin Honed Finished
600mm x 370mm x 170mm
13 kg (27 lbs)
Obscure Cover
Colour Dua
Pantone Matching

* Obscure Cover requires a standard drop-in drain.

MARCELA
COLLECTION

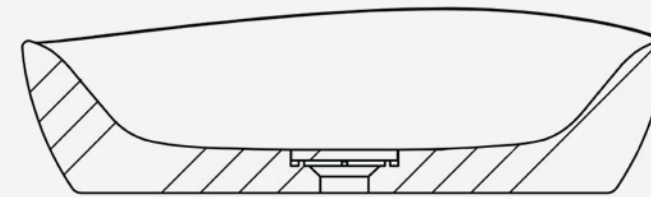

FRONT

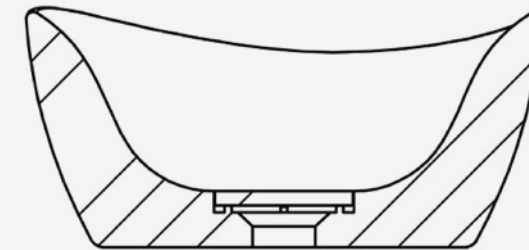

SIDE

COLLECTION:

MIA / SOPH-M4V

- Material: Mineral Glass Composite
- Finish: Satin Honed Finished
- Dimension: 675mm x 378mm x 180mm
- Weight: 10 kg (21 lbs)
- Drain Opening: Obscure Cover
- Available Options: Colour Dua
Pantone Matching

* Obscure Cover requires a standard drop-in drain.

MIA

COLLECTION

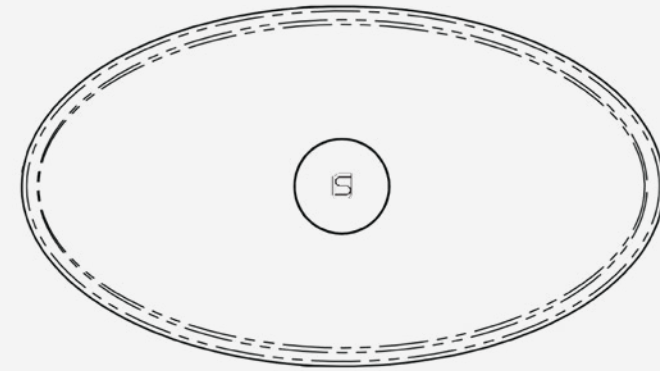

TOP

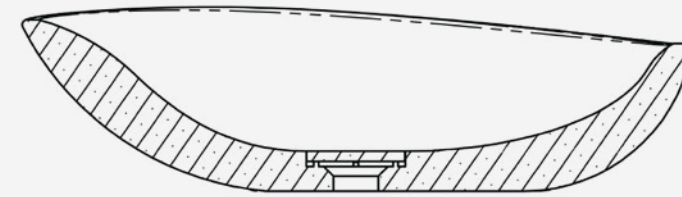

FRONT

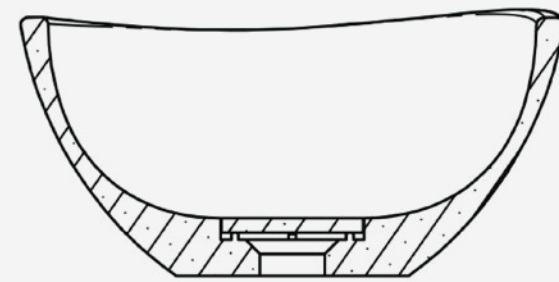

SIDE

COLLECTION:

MIKAYLA / SOPH-M5V

- Material: Mineral Glass Composite
- Finish: Satin Honed Finished
- Dimension: 457mm x 418mm x 180mm
- Weight: 7 kg (15 lbs)
- Drain Opening: Obscure Cover
- Available Options: Colour Dua
Pantone Matching

* Obscure Cover requires a standard drop-in drain.

MIKAYLA

COLLECTION

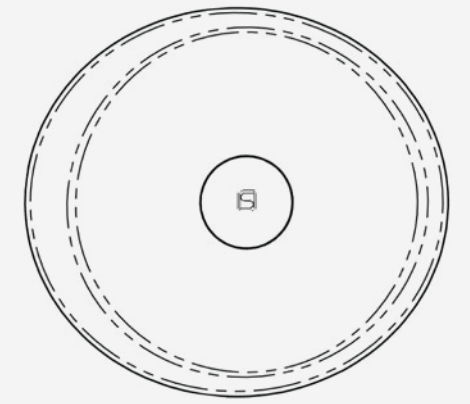

TOP

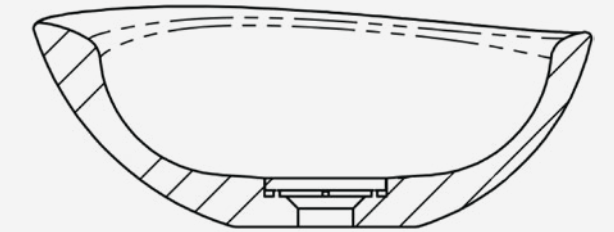

FRONT

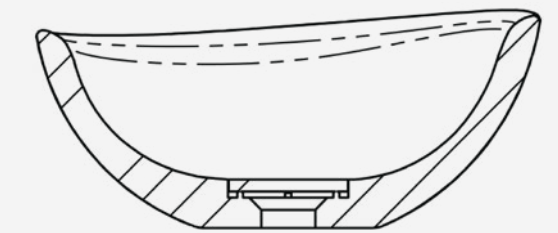

SIDE

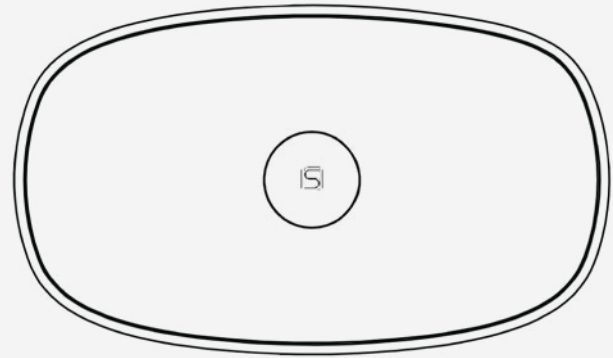

TOP

COLLECTION:

Material:
Finish:
Dimension:
Weight:
Drain Opening:
Available Options:

MASON / SOPH-M6V
Mineral Glass Composite
Satin Honed Finished
620mm x 363mm x 130mm
11 kg (24 lbs)
Obscure Cover
Colour Dua
Pantone Matching

* Obscure Cover requires a standard drop-in drain.

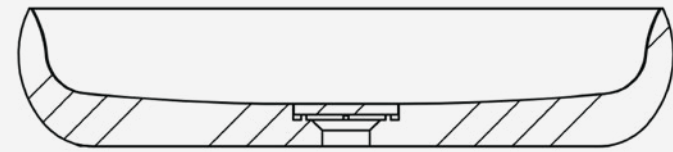

FRONT

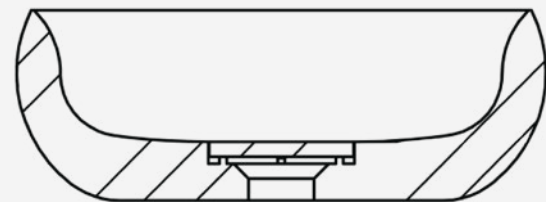

SIDE

MASON

COLLECTION

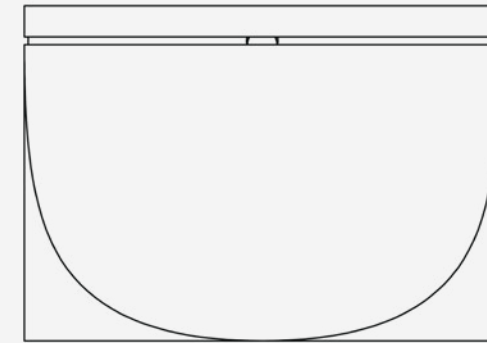

TOP

COLLECTION:

Material:
Finish:
Dimension:
Weight:
Drain Opening:
Available Options:

MAREA / SOPH-M7V
Mineral Glass Composite
Satin Honed Finished
610mm x 430mm x 160mm
15 kg (33 lbs)
Evanesce Drain
Colour Dua
Pantone Matching

* Evanesce has an integrated 1-1/2" threaded P-trap adapter.

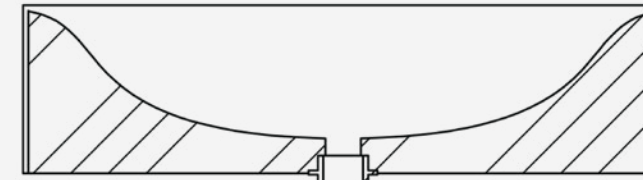

FRONT

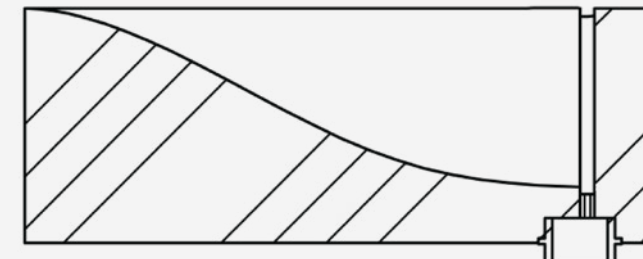

SIDE

MAREA

COLLECTION



COLLECTION:

NOBLE / SOPH-N1V

Material: Mineral Glass Composite
 Finish: Satin Honed Finished
 Dimension: 405mm x 405mm x 130mm
 Weight: 11 kg (25 lbs)
 Drain Opening: Obscure Cover
 Available Options: Colour Dua
 Pantone Matching

* Obscure Cover requires a standard drop-in drain.

NOBLE

COLLECTION

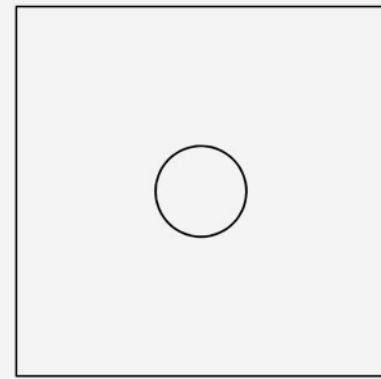

TOP

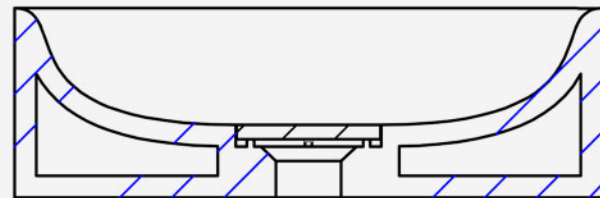

FRONT

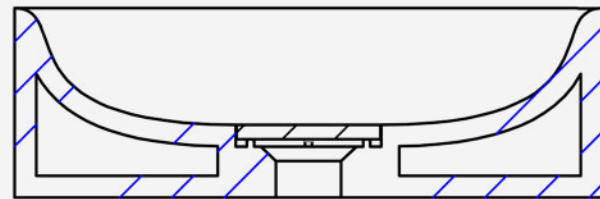

SIDE

COLLECTION:

OLIVIA / SOPH-O1V

Material: Mineral Glass Composite
 Finish: Satin Honed Finished
 Dimension: 510mm x 355mm x 130mm
 Weight: 7 kg (16 lbs)
 Drain Opening: Obscure Cover
 Available Options: Colour Dua
 Pantone Matching

* Obscure Cover requires a standard drop-in drain.

OLIVIA

COLLECTION

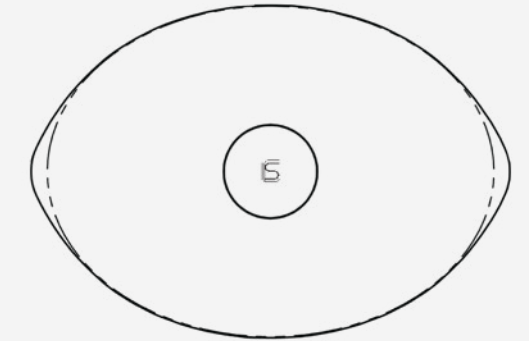

TOP

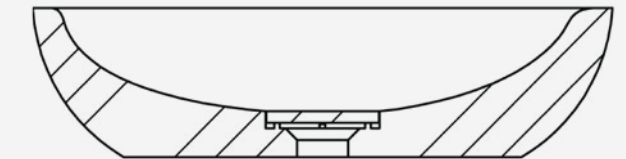

FRONT

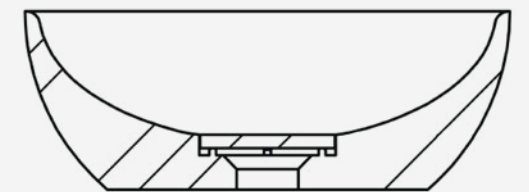

SIDE

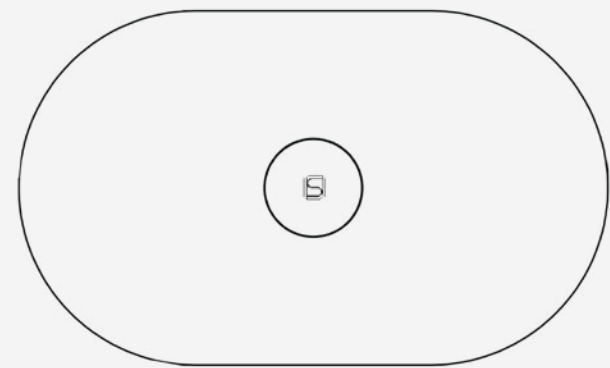

TOP

COLLECTION:

Material:
Finish:
Dimension:
Weight:
Drain Opening:
Available Options:

PHOENIX / SOPH-PIV

Mineral Glass Composite
Satin Honed Finished
600mm x 360mm x 128mm
11 kg (23 lbs)
Obscure Cover
Colour Dua
Pantone Matching

* Obscure Cover requires a standard drop-in drain.

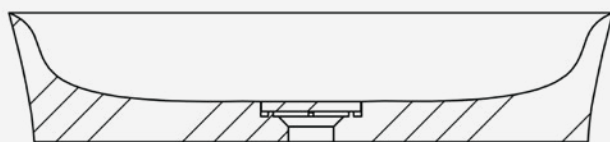

FRONT

PHOENIX
COLLECTION

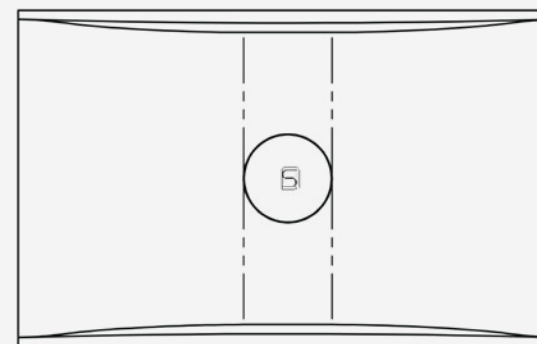

TOP

COLLECTION:

Material:
Finish:
Dimension:
Weight:
Drain Opening:
Available Options:

SERENE / SOPH-SIV

Mineral Glass Composite
Satin Honed Finished
610mm x 380mm x 180mm
10 kg (22 lbs)
Obscure Cover
Colour Dua
Pantone Matching

* Obscure Cover requires a standard drop-in drain.

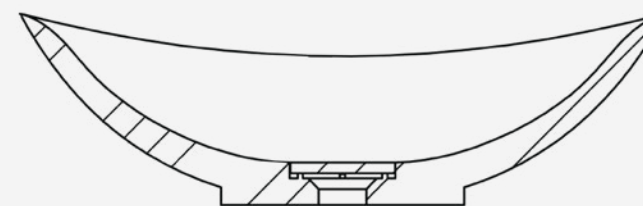

FRONT

SERENE
COLLECTION

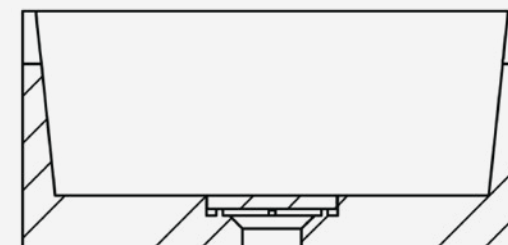

SIDE

COLLECTION:

SILVA / SOPH-S2V

Material: Mineral Glass Composite
Finish: Satin Honed Finished
Dimension: 610mm x 400mm x 210mm
Weight: 11 kg (25 lbs)
Drain Opening: Obscure Cover
Available Options: Colour Dua
Pantone Matching

* Obscure Cover requires a standard drop-in drain.

SILVA
COLLECTION

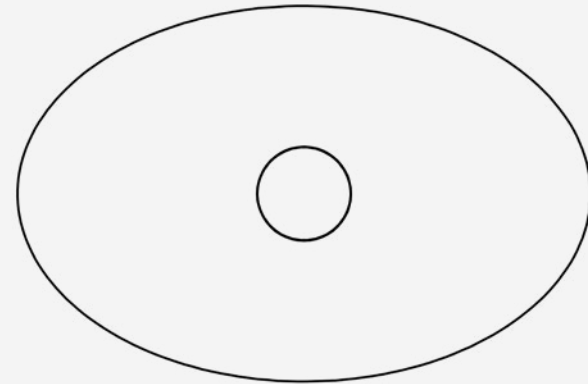

TOP

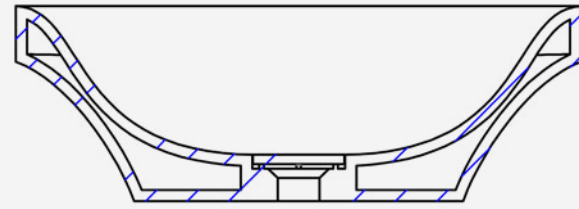

FRONT

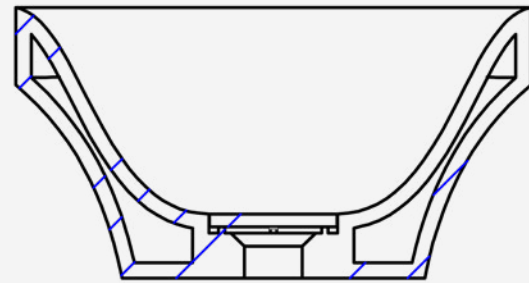

SIDE





INTEGRATED COUNTER SINK

INTEGRATED COUNTER SINK COLLECTIONS:

PIXELS	94	MARCELA	104
AHRI	98	MIA	106
CHRISTOPH	100	MIKAYLA	108
ELIZABETH	102	MASON	110

WALLMOUNTED WASHBASIN COLLECTIONS:

AHRI	114
CHRISTOPH	115
MIA	116
MAREA	117

PIXELS

NEW DESIGN

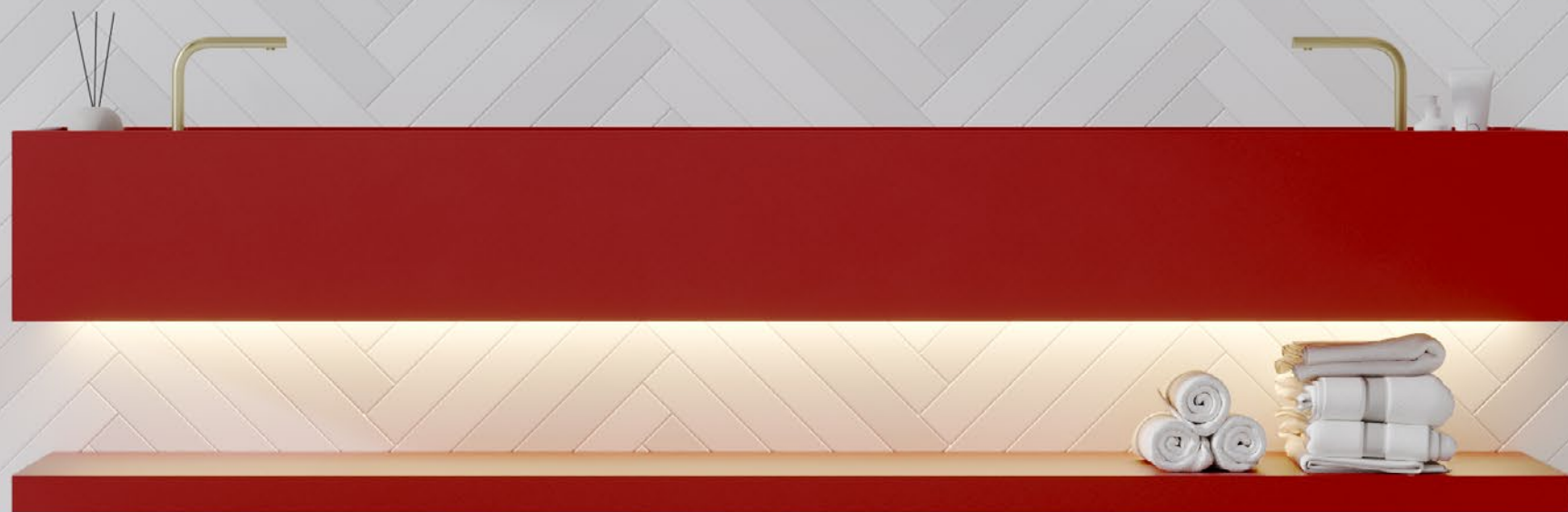



MADE TO ORDER

PIXELS
NEW DESIGN

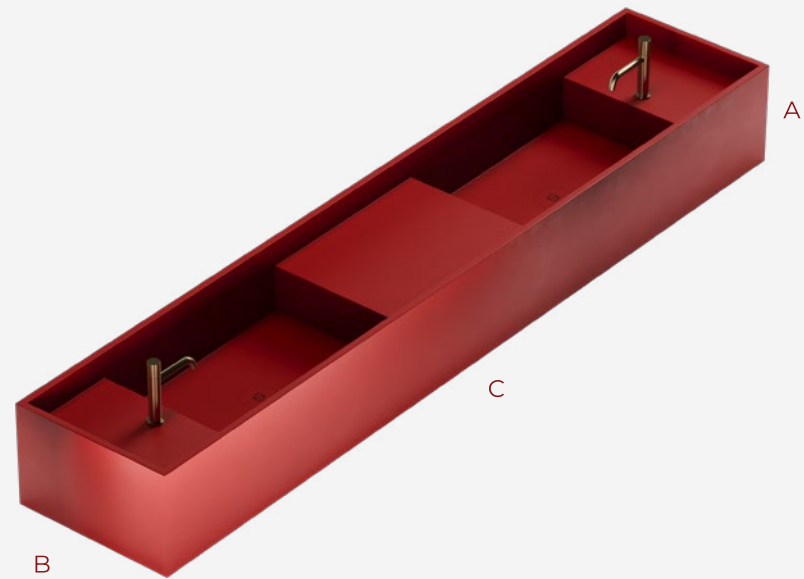

Made to order based on the information in the table on this page. Sides can be left open for wall to wall applications or close on both sides. Single basin left, center, or right. Double basin left and right. Fixed to wall or cabinetry.

MODEL NUMBER: SOPH-P2CS-MTO



TOP



FRONT

A	B	C
25	40	110 to 365
25	48	110 to 365
25	55	110 to 365
30	40	110 to 365
30	48	110 to 365
30	55	110 to 365
35	40	110 to 365
35	48	110 to 365
35	55	110 to 365
Custom	Custom	Custom

size in CM
Specify Single or Double Sink

MADE TO ORDER

MODEL NUMBER: SOPH-A1CS-MTO

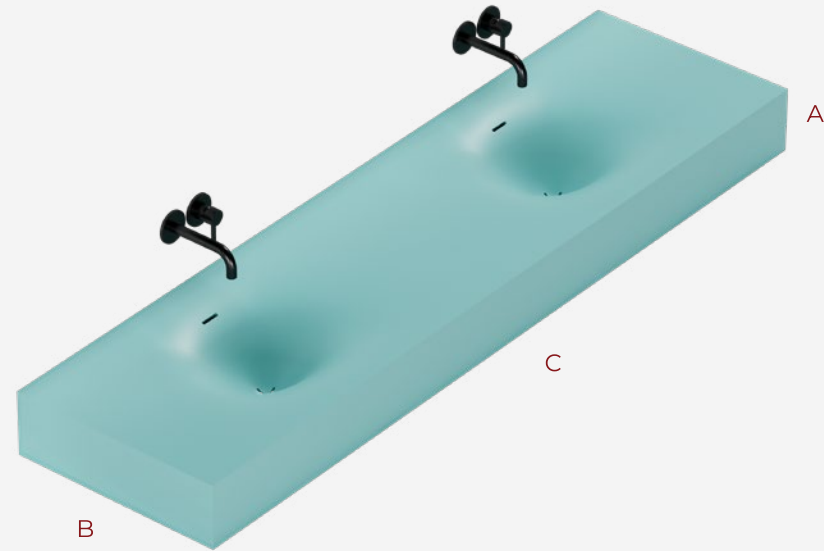

Made to order based on the information in the table on this page. Sides can be left open for wall to wall applications or close on both sides. Single basin left, center, or right. Double basin left and right. Fixed to wall or cabinetry.

AHRI
COLLECTION

A	B	C
25	48	110 to 365
25	55	110 to 365
30	48	110 to 365
30	55	110 to 365
35	48	110 to 365
35	55	110 to 365
Custom	Custom	Custom

size in CM
Specify Single or Double Sink

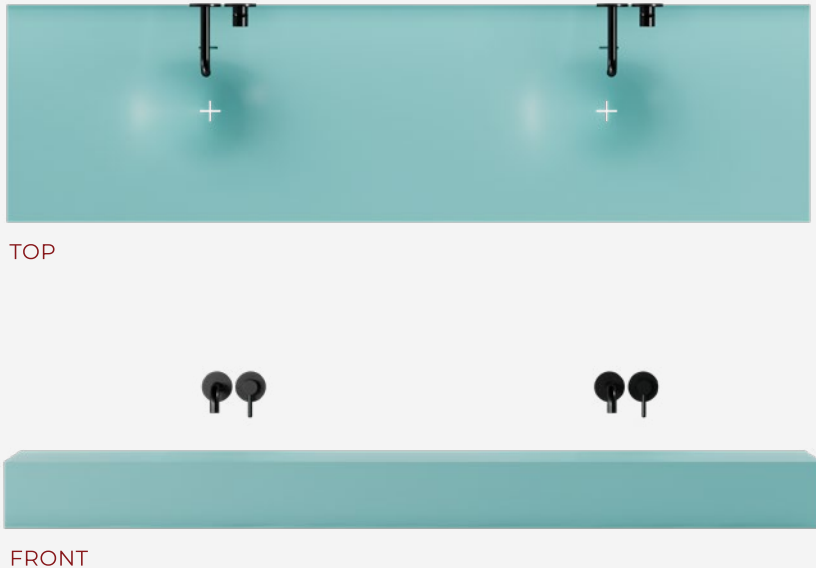

STANDARD INTEGRATED SINK

COLLECTION: AHRI / SOPH-A1CS925
Material: Mineral Glass Composite
Finish: Satin Honed Finished
Standard Drain: SOPHTONE + Drain
Dimension: 925mm x 555mm x 15mm
Basin Depth: 150mm
Available Options: Colour Dua

* SOPHSTONE + Drain has an integrated 1-1/2" treaded p-trap adapter.

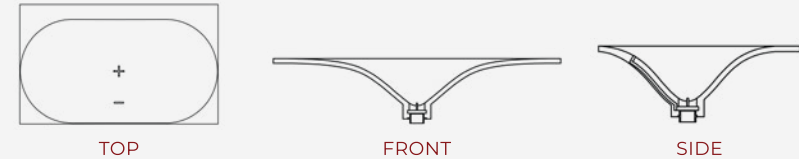

COLLECTION: AHRI / SOPH-A1CS1230
Material: Mineral Glass Composite
Finish: Satin Honed Finished
Standard Drain: SOPHTONE + Drain
Dimension: 1230mm x 555mm x 15mm
Basin Depth: 150mm
Available Options: Colour Dua

* SOPHSTONE + Drain has an integrated 1-1/2" treaded p-trap adapter.

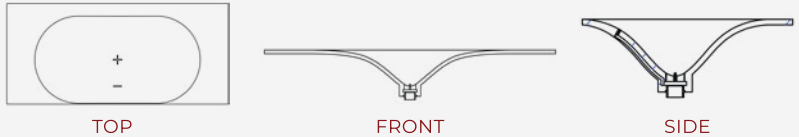

STANDARD INTEGRATED SINK

COLLECTION: CHRISTOPH / SOPH-C1CS925

Material: Mineral Glass Composite
 Finish: Satin Honed Finished
 Standard Drain: Obscure Drain Opening
 Dimension: 925mm x 555mm x 15mm
 Basin Depth: 175mm
 Available Options: Colour Dua

* Obscure drain opening requires a drop-in drain.

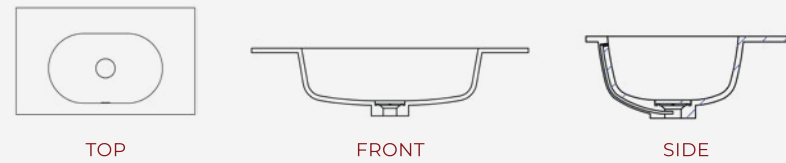

COLLECTION: CHRISTOPH / SOPH-C1CS1230

Material: Mineral Glass Composite
 Finish: Satin Honed Finished
 Standard Drain: Obscure Drain Opening
 Dimension: 1230mm x 555mm x 15mm
 Basin Depth: 175mm
 Available Options: Colour Dua

* Obscure drain opening requires a drop-in drain.

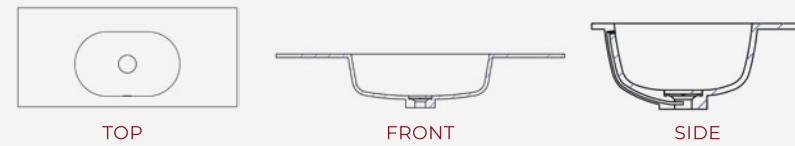

MADE TO ORDER

MODEL NUMBER: SOPH-C1CS-MTO

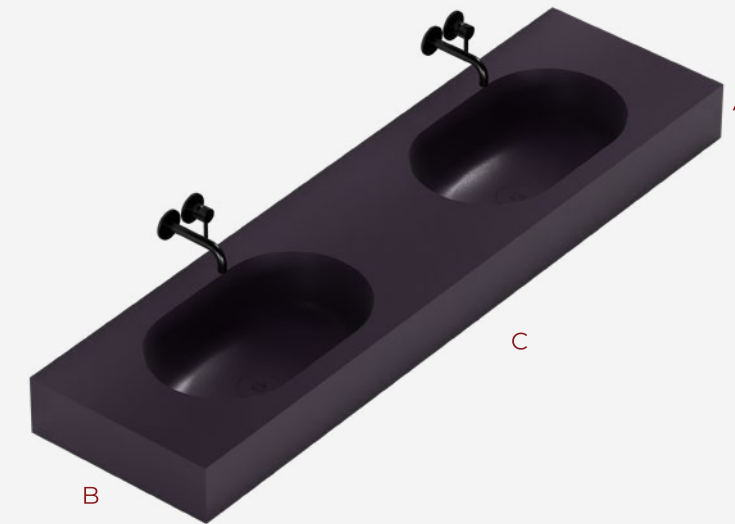

Made to order based on the information in the table on this page. Sides can be left open for wall to wall applications or close on both sides. Single basin left, center, or right. Double basin left and right. Fixed to wall or cabinetry.

CHRISTOPH COLLECTION

A	B	C
25	48	110 to 365
25	55	110 to 365
30	48	110 to 365
30	55	110 to 365
35	48	110 to 365
35	55	110 to 365
Custom	Custom	Custom

size in CM

Specify Single or Double Sink



TOP

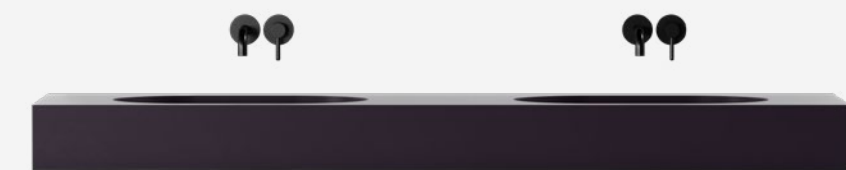

FRONT

MADE TO ORDER

MODEL NUMBER: SOPH-E1CS-MTO

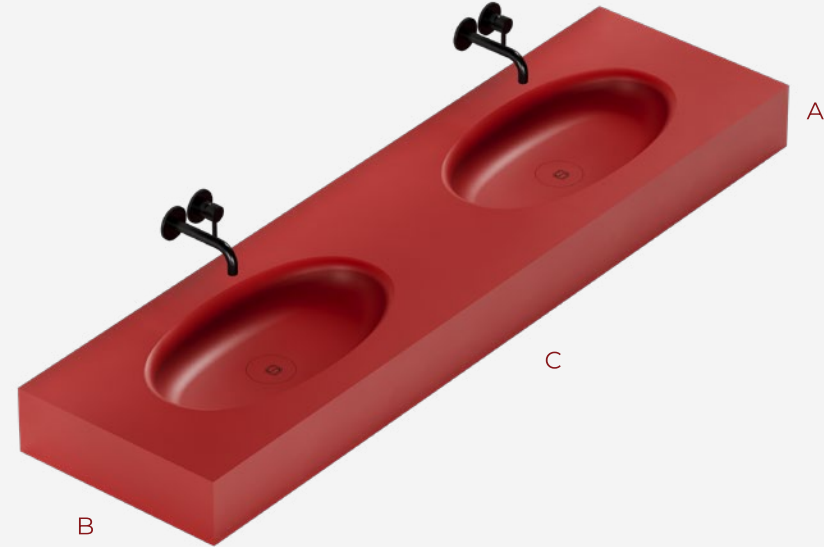

Made to order based on the information in the table on this page. Sides can be left open for wall to wall applications or close on both sides. Single basin left, center, or right. Double basin left and right. Fixed to wall or cabinetry.

ELIZABETH
COLLECTION

A	B	C
25	48	110 to 365
25	55	110 to 365
30	48	110 to 365
30	55	110 to 365
35	48	110 to 365
35	55	110 to 365
Custom	Custom	Custom

size in CM
Specify Single or Double Sink



TOP



FRONT

STANDARD INTEGRATED SINK

COLLECTION: ELIZABETH / SOPH-E1CS925
Material: Mineral Glass Composite
Finish: Satin Honed Finished
Standard Drain: Obscure Drain Opening
Dimension: 925mm x 555mm x 15mm
Basin Depth: 90mm
Available Options: Colour Dua

COLLECTION: ELIZABETH / SOPH-E1CS1230
Material: Mineral Glass Composite
Finish: Satin Honed Finished
Standard Drain: Obscure Drain Opening
Dimension: 1230mm x 555mm x 15mm
Basin Depth: 90mm
Available Options: Colour Dua

* Obscure drain opening requires a drop-in drain.

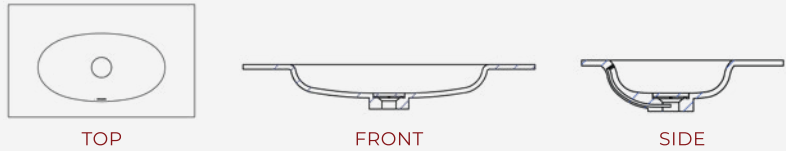

* Obscure drain opening requires a drop-in drain.



STANDARD INTEGRATED SINK

COLLECTION: MARCELA / SOPH-M3CS925

Material: Mineral Glass Composite
 Finish: Satin Honed Finished
 Standard Drain: Obscure Drain Opening
 Dimension: 925mm x 555mm x 15mm
 Basin Depth: 100mm
 Available Options: Colour Dua

* Obscure drain opening requires a drop-in drain.

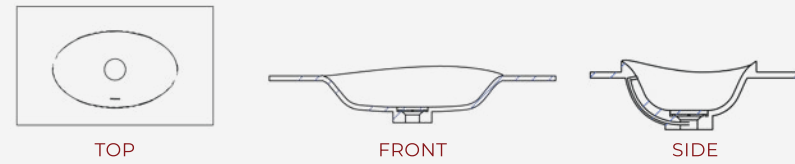

COLLECTION: MARCELA / SOPH-M3CS1230

Material: Mineral Glass Composite
 Finish: Satin Honed Finished
 Standard Drain: Obscure Drain Opening
 Dimension: 1230mm x 555mm x 15mm
 Basin Depth: 100mm
 Available Options: Colour Dua

* Obscure drain opening requires a drop-in drain.



MADE TO ORDER

MODEL NUMBER: SOPH-M3CS-MTO



Made to order based on the information in the table on this page. Sides can be left open for wall to wall applications or close on both sides. Single basin left, center, or right. Double basin left and right. Fixed to wall or cabinetry.

MARCELA COLLECTION

A	B	C
25	48	110 to 365
25	55	110 to 365
30	48	110 to 365
30	55	110 to 365
35	48	110 to 365
35	55	110 to 365
Custom	Custom	Custom

size in CM

Specify Single or Double Sink

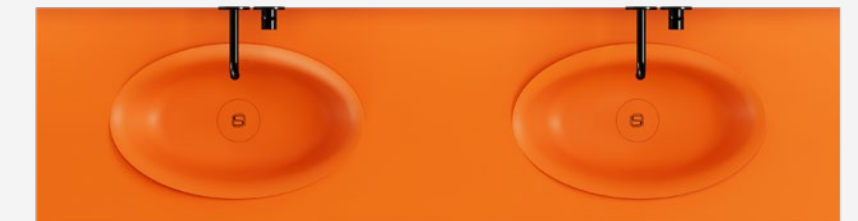

TOP



FRONT

MADE TO ORDER

MODEL NUMBER: SOPH-M4CS-MTO

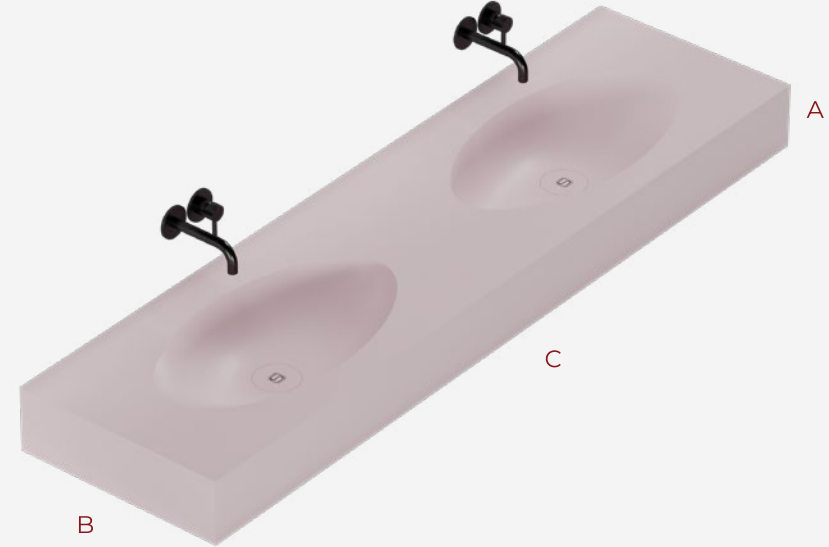

Made to order based on the information in the table on this page. Sides can be left open for wall to wall applications or close on both sides. Single basin left, center, or right. Double basin left and right. Fixed to wall or cabinetry.

MIA
COLLECTION

A	B	C
25	48	110 to 365
25	55	110 to 365
30	48	110 to 365
30	55	110 to 365
35	48	110 to 365
35	55	110 to 365
Custom	Custom	Custom

size in CM
Specify Single or Double Sink



TOP



FRONT

STANDARD INTEGRATED SINK

COLLECTION: MIA / SOPH-M4CS925
Material: Mineral Glass Composite
Finish: Satin Honed Finished
Standard Drain: Obscure Drain Opening
Dimension: 925mm x 555mm x 15mm
Basin Depth: 108mm
Available Options: Colour Dua

* Obscure drain opening requires a drop-in drain.

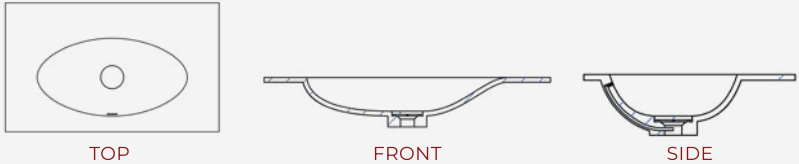

TOP

FRONT

SIDE

COLLECTION: MIA / SOPH-M4CS1230
Material: Mineral Glass Composite
Finish: Satin Honed Finished
Standard Drain: Obscure Drain Opening
Dimension: 1230mm x 555mm x 15mm
Basin Depth: 108mm
Available Options: Colour Dua

* Obscure drain opening requires a drop-in drain.

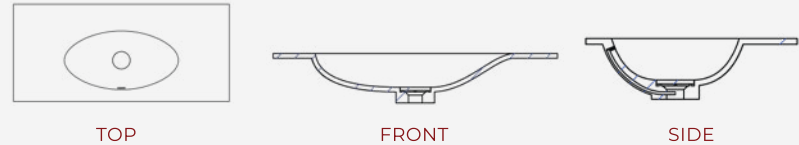

TOP

FRONT

SIDE



STANDARD INTEGRATED SINK

COLLECTION: MIKAYLA / SOPH-M5CS925
Material: Mineral Glass Composite
Finish: Satin Honed Finished
Standard Drain: Obscure Drain Opening
Dimension: 925mm x 555mm x 15mm
Basin Depth: 114mm
Available Options: Colour Dua (as shown)

* Obscure drain opening requires a drop-in drain.

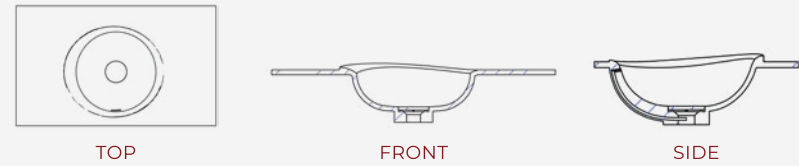

COLLECTION: MIKAYLA / SOPH-M5CS1230
Material: Mineral Glass Composite
Finish: Satin Honed Finished
Standard Drain: Obscure Drain Opening
Dimension: 1230mm x 555mm x 15mm
Basin Depth: 114mm
Available Options: Colour Dua (as shown)

* Obscure drain opening requires a drop-in drain.

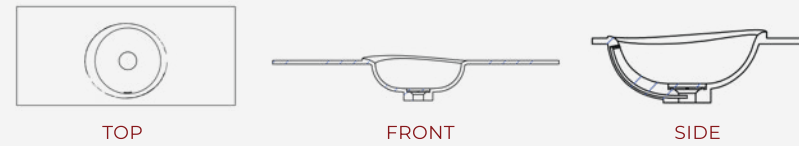

MADE TO ORDER

MODEL NUMBER: SOPH-M5CS-MTO

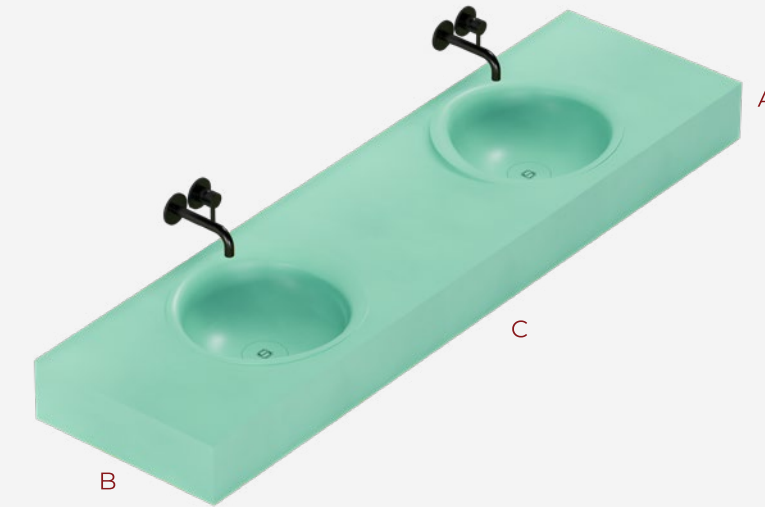

Made to order based on the information in the table on this page. Sides can be left open for wall to wall applications or close on both sides. Single basin left, center, or right. Double basin left and right. Fixed to wall or cabinetry.

MIKAYLA
COLLECTION

A	B	C
25	48	110 to 365
25	55	110 to 365
30	48	110 to 365
30	55	110 to 365
35	48	110 to 365
35	55	110 to 365
Custom	Custom	Custom

size in CM
Specify Single or Double Sink

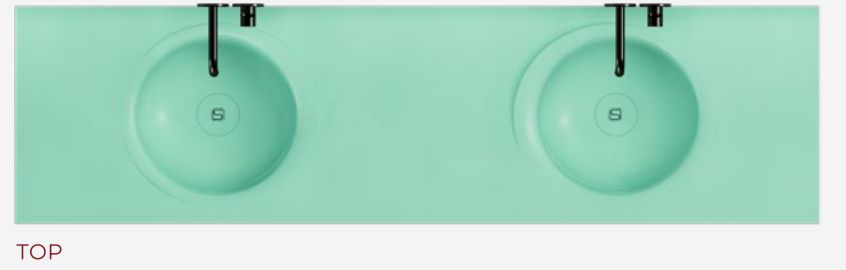

MADE TO ORDER

MODEL NUMBER: SOPH-M6CS-MTO

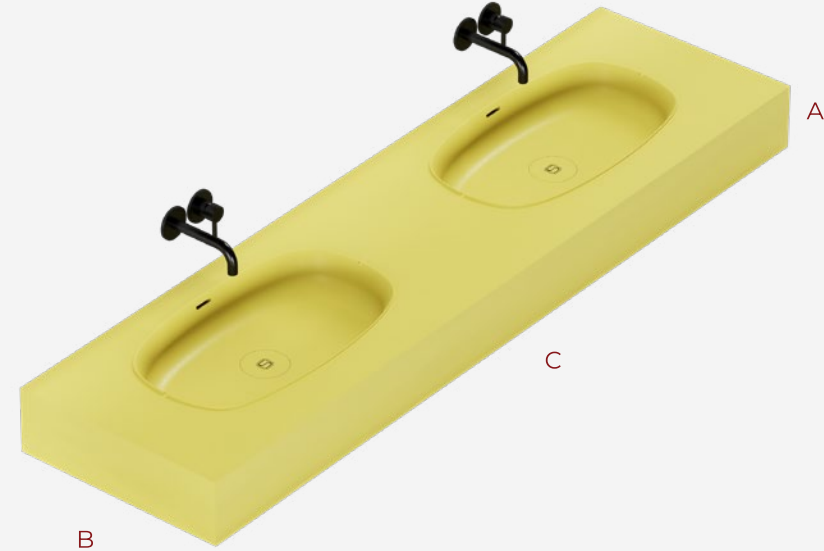

Made to order based on the information in the table on this page. Sides can be left open for wall to wall applications or close on both sides. Single basin left, center, or right. Double basin left and right. Fixed to wall or cabinetry.

MASON
COLLECTION

A	B	C
25	48	110 to 365
25	55	110 to 365
30	48	110 to 365
30	55	110 to 365
35	48	110 to 365
35	55	110 to 365
Custom	Custom	Custom

size in CM
Specify Single or Double Sink



TOP



FRONT

STANDARD INTEGRATED SINK

COLLECTION: MASON / SOPH-M6CS925
Material: Mineral Glass Composite
Finish: Satin Honed Finished
Standard Drain: Obscure Drain Opening
Dimension: 925mm x 555mm x 15mm
Basin Depth: 85mm
Available Options: Colour Dua (as shown)

* Obscure drain opening requires a drop-in drain.

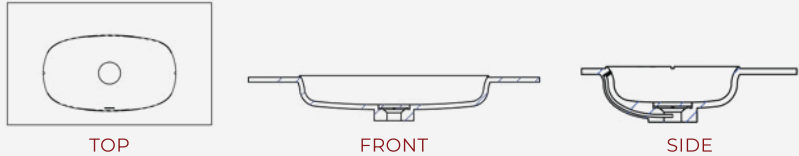

TOP

FRONT

SIDE

COLLECTION: MASON / SOPH-M6CS1230
Material: Mineral Glass Composite
Finish: Satin Honed Finished
Standard Drain: Obscure Drain Opening
Dimension: 1230mm x 555mm x 15mm
Basin Depth: 85mm
Available Options: Colour Dua (as shown)

* Obscure drain opening requires a drop-in drain.



TOP

FRONT

SIDE





WALLMOUNTED
WASHBASIN





AHRI

COLLECTION



CHRISTOPH

COLLECTION

COLLECTION: AHRI / SOPH-AIWMD (Double)

Material: Mineral Glass Composite
 Finish: Satin Honed Finished
 Basin: Double
 Dimension: 1840mm x 482mm x 400mm
Custom configuration available
 Basin Depth: 150mm
 Drain Option: SOPHSTONE + Drain
 Available Options: Colour Dua

* SOPHSTONE + drain has an integrated 1-1/2" treaded p-trap adapter.



COLLECTION: AHRI / SOPH-A1WM (Single)

Material: Mineral Glass Composite
 Finish: Satin Honed Finished
 Basin: Single
 Dimension: 920mm x 482mm x 400mm
Custom configuration available
 Basin Depth: 150mm
 Drain Option: SOPHSTONE + Drain
 Available Options: Colour Dua

* SOPHSTONE + drain has an integrated 1-1/2" treaded p-trap adapter.



COLLECTION: CHRISTOPH / SOPH-C1WMD (Double)

Material: Mineral Glass Composite
 Finish: Satin Honed Finished
 Basin: Double
 Dimension: 1840mm x 530mm x 400mm
Custom configuration available
 Basin Depth: 175mm
 Drain Option: Obscure Drain Opening
 Available Options: Colour Dua

* Obscure Cover requires a standard drop-in drain.

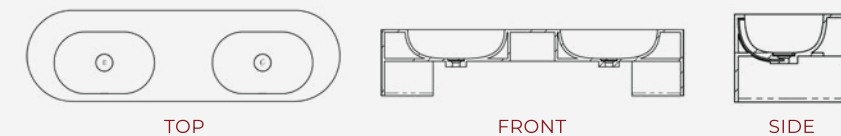

COLLECTION: CHRISTOPH / SOPH-C1WM (Single)

Material: Mineral Glass Composite
 Finish: Satin Honed Finished
 Basin: Single
 Dimension: 1230mm x 482mm x 400mm
Custom configuration available
 Basin Depth: 108mm
 Drain Option: Obscure Drain Opening
 Available Options: Colour Dua

* Obscure Cover requires a standard drop-in drain.

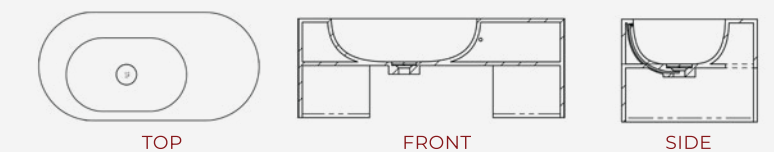



MIA
COLLECTION

COLLECTION: MIA / SOPH-M4WM
Material: Mineral Glass Composite
Finish: Satin Honed Finished
Basin: Single
Dimension: 1230mm x 482mm x 400mm
Custom configuration available
Basin Depth: 108mm
Drain Option: Obscure Drain Opening
Available Options: Colour Dua

* Obscure Cover requires a standard drop-in drain.

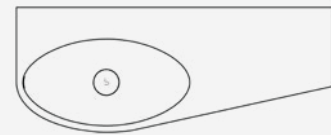

TOP

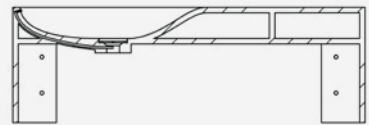

FRONT

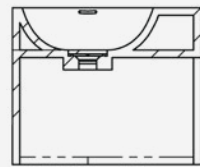

SIDE



MAREA
COLLECTION

COLLECTION: MAREA / SOPH-M7WMD (Double)
Material: Mineral Glass Composite
Finish: Satin Honed Finished
Basin: Double
Dimension: 2150mm x 530mm x 190mm
Custom configuration available
Basin Depth: 80mm
Drain Option: Evanesce Drain
Available Options: Colour Dua

* Evanesce has an integrated 1-1/2" threaded P-trap adapter.

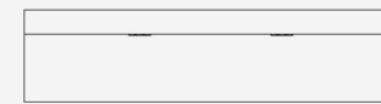

TOP

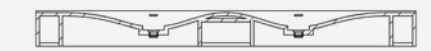

FRONT

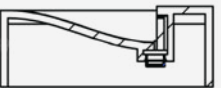

SIDE

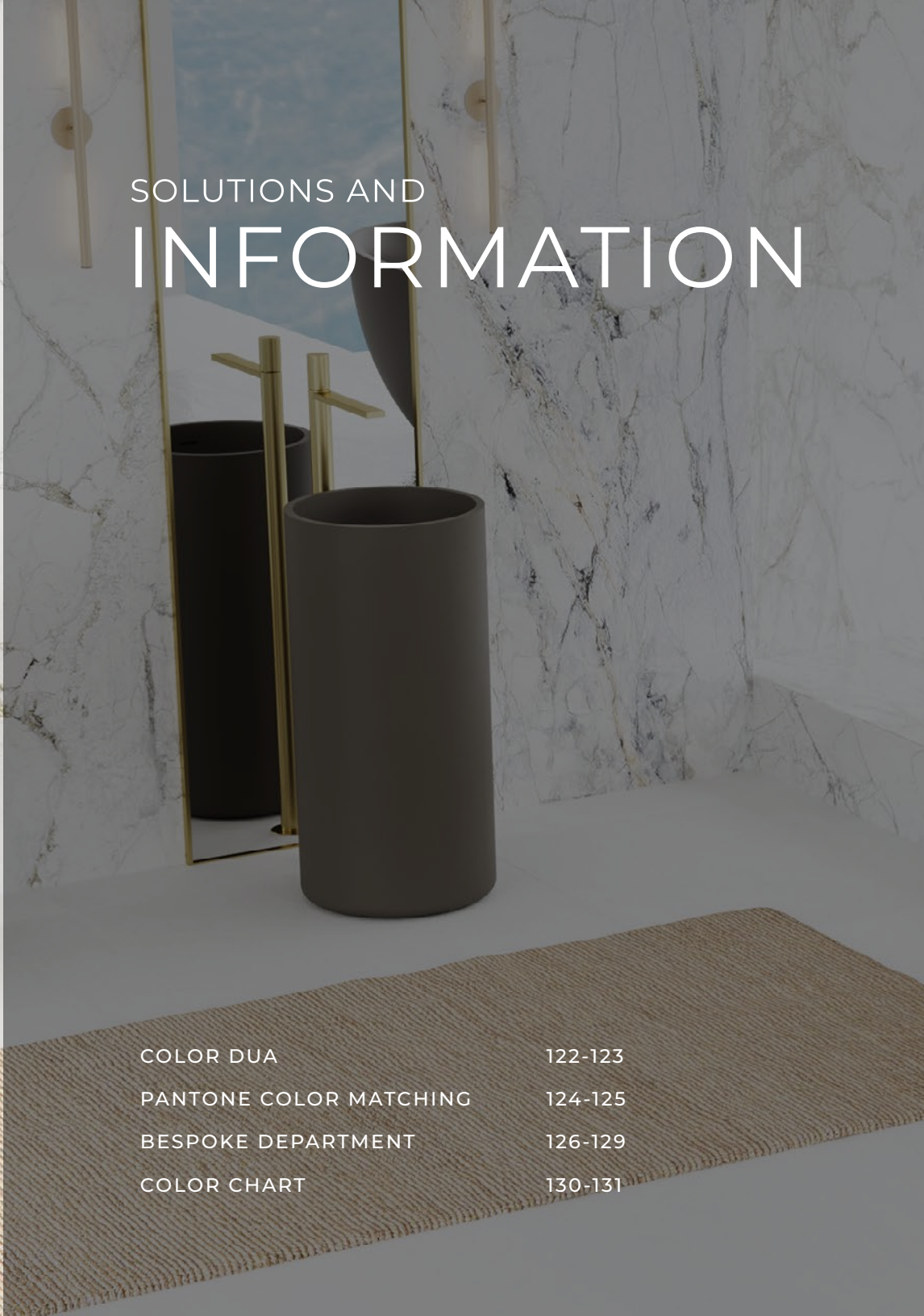

SOLUTIONS AND INFORMATION

COLOR DUA	122-123
PANTONE COLOR MATCHING	124-125
BESPOKE DEPARTMENT	126-129
COLOR CHART	130-131



COLOR

is a power that directly influences the

SOUL.

- Wassily Kandinsky



COLOUR

DUA

Embellish your bathware with a complimentary color. Colour Dua combines a second colors of your choice to your SOPHSTONE bathware.





REFLECT A

DIFFERENT HUE

BESPOKE

DEPARTMENT

The **SOPHSTONE** Bespoke Division is devoted to assisting designers, architects, project managers, specifiers, developers, and consultants in turning their most creative ideas into reality – from private estates to large scale resort projects – creating Exclusive Bathware that will define the space.

- EXCLUSIVITY
- PERSONALIZED SERVICE
- CONCEPT TO COMPLETION
- MEETING PROJECT DEADLINES
- INTERNATIONAL CONSULTING TEAM



BESPOKE

DEPARTMENT

- PARK HYATT - MALDIVES
- AYADA RESORT - MALDIVES
- THE SAINT REGIS LANGKAWI - MALAYSIA
- RITZ CARLTON RESERVE RESIDENCES - COSTA RICA
- CONRAD HOTEL - DOWNTOWN LOS ANGELES
- FOUR SEASONS AVIARA - CALIFORNIA
- THOMPSON HOTEL RIVERWALK - TEXAS
- LA CANTERA RESORT - TEXAS
- THE MARMARA MANHATTAN - NEW YORK
- HARDROCK HOTEL - FLORIDA
- THE AVERY - SAN FRANCISCO
- THE BOBBY HOTEL - NASHVILLE
- OMNI HOTEL AND RESORT
- THE SIREN HOTEL - MICHIGAN
- HOKELE HOTEL - HAWAII
- THE PRESCOTT HOTEL - CALIFORNIA
- DOUBLE TREE - SAN DIEGO

PREMIUM COLORS

Color is a representation, please order a physical color sample.

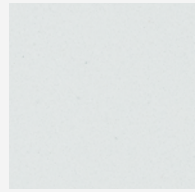

COTTON

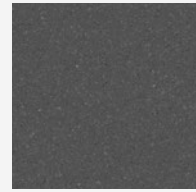

ASH

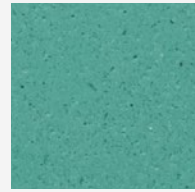

AQUAMARINE

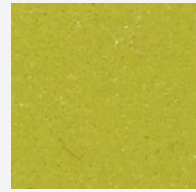

AURORA

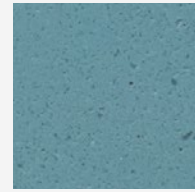

CELESTE

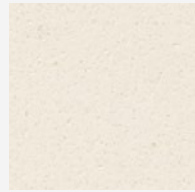

COSMIC LATTE

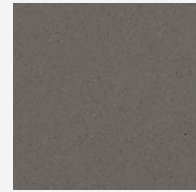

DOVETAIL

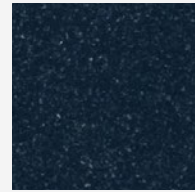

GALAXY

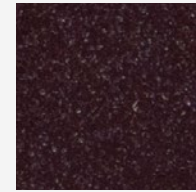

NEBULA

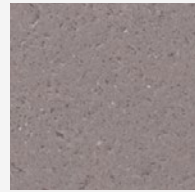

NIMBUS

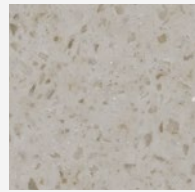

PEARL MIST

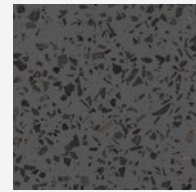

RIVER SLATE

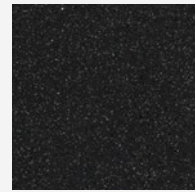

SHADOW



SHORELINE



SOLAR IRRADIANCE

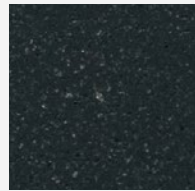

STORM

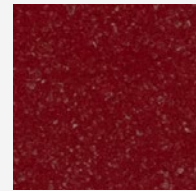

THE ROSE



TUSCAN

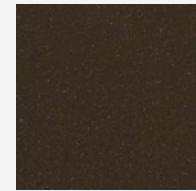

URSA

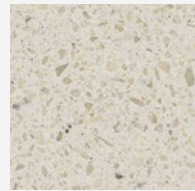

WINTERS GOLD

COLOR CALLOUTS

Standard color:

CN Cotton

Special order color:

AH Ash
 AE Aquamarine
 AA Aurora
 CE Celeste
 CL Cosmic Latte
 DL Dovetail
 GY Galaxy
 NA Nebula
 NS Nimbus
 PM Pearl Mist
 RS River Slate
 SW Shadow
 SE Shoreline
 SI Solar Irradiance
 SM Storm
 TR The Rose
 TN Tuscan
 UA Ursa
 WG Winters Gold

HOW TO ORDER

Ordering Call-outs:

Format: MODEL-COLOR

Example: SOPH-SIFB-CN

ADDITIONAL INFORMATION

- Cotton is our standard color option.
- All other colors are special order.



WHEN FUNCTION + ART COEXIST

SALES - NEW WORLD

Headquarters – California, USA
Phone: +(1).559.457.0216
Inside USA: 1.844.539.1801
email: sales@sophstone.com

SALES - OLD WORLD

Bali, Indonesia
WhatsApp: +62 819 4900 3573
email: asia.sales@sophstone.com